



Official Result Book

**MUNGYEONG
KOREA** Friendship Together
Peace Forever

2015

6th CISM
World Games

Friendship
Together,

Peace
Forever



Wrestling
2015.10.6 ~ 10.10



MUNGYEONG KOREA 2015
6th CISM World Games

Wrestling
레슬링
Men's Greco-Roman
남자 그레고로만형



Number of Entries by Nation
국가별 참가인원 수

As of FRI 9 OCT 2015

Nation	Total entries by weight category								Total Competitors
	59kg	66kg	71kg	75kg	80kg	85kg	98kg	130kg	
ALG - Algeria		1	1				1		3
ARM - Armenia	1	1	1		1				4
AZE - Azerbaijan	1		1	1	1	1	1		6
BLR - Belarus							1	1	2
BRA - Brazil	1			1			1		3
CHN - China	1			1	1		1	1	5
DOM - Dominican Republic								1	1
EGY - Egypt	1	1	1	1	1	1	1	1	8
EST - Estonia					1			1	2
FIN - Finland			1						1
GEO - Georgia								1	1
GER - Germany	1	1			1	1			4
GRE - Greece				1		1			2
IND - India	1	1	1	1	1	1	1		7
IRI - Iran	1	1	1	1	1	1	1	1	8
KAZ - Kazakhstan	1	1	1		1		1		5
KOR - Korea, R.	1	1	1	1	1	1			6
LIB - Lebanon	1		1		1			1	4
LTU - Lithuania		1			1	1	1		4
MGL - Mongolia					1	1	1	1	4
NGR - Nigeria				1					1
PAK - Pakistan		1		1					2
POL - Poland	1	1	1	1		1		1	6
RUS - Russia	1	1	1	1	1	1	1	1	8
SUI - Switzerland				1					1
SVK - Slovakia			1						1
SYR - Syria		1		1		1			3
TUN - Tunisia				1					1
TUR - Turkey	1	1	1					1	4
UKR - Ukraine	1	1	1	1	1	1	1	1	8
USA - United States of America	1	1	1	1		1	1	1	7
Total: 31	16	16	16	17	15	14	14	14	122



MUNGYEONG KOREA 2015
6th CISM World Games

Wrestling
레슬링
Men's Freestyle
남자 자유형



Number of Entries by Nation

국가별 참가인원 수

As of FRI 9 OCT 2015

Nation	Total entries by weight category								Total Competitors
	57kg	61kg	65kg	70kg	74kg	86kg	97kg	125kg	
ALG - Algeria		1						1	2
ARM - Armenia	1	1	1	1					4
AZE - Azerbaijan	1	1	1	1		1	1		6
BLR - Belarus				1		1	1		3
BRA - Brazil						1			1
CHN - China		1			1	1	1	1	5
EGY - Egypt		1	1	1	1	1		1	6
GEO - Georgia		1	1						2
GER - Germany	1	1	1	1	1	1	1	1	8
GRE - Greece					1				1
GUI - Guinea					1			1	2
IND - India	1	1	1	1	1	1	1	1	8
IRI - Iran	1	1	1	1	1	1	1	1	8
KAZ - Kazakhstan	1	1	1	1	1	1	1		7
KOR - Korea, R.	1	1	1	1	1	1	1	1	8
LAT - Latvia						1			1
LIB - Lebanon	1			1		1		1	4
MGL - Mongolia	1	1	1	1	1	1	1	1	8
MKD - FYROM			1						1
NGR - Nigeria		1							1
PAK - Pakistan	1	1		1					3
POL - Poland			1		1			1	3
RUS - Russia	1	1	1	1	1	1	1	1	8
SUI - Switzerland		1				1			2
SYR - Syria						1			1
TUN - Tunisia					1				1
TUR - Turkey		1	1		1			1	4
UAE - United Arab Emirates				1	1	1			3
UKR - Ukraine		1	1	1	1	1	1	1	7
USA - United States of America	1	1	1	1	1	1	1		7
Total: 30	12	19	16	16	17	19	12	14	125



MUNGYEONG KOREA 2015
6th CISM World Games

Wrestling

레슬링

Men's Greco-Roman

남자 그레고로만형



Entry List by Nation

국가별 참가인원 목록

As of FRI 9 OCT 2015

CDM	Name	Weight Category	Date of Birth
ALG	- Algeria		
	BENAÏSSA Tarek Aziz	66kg	7 APR 1991
	BOUDJEMLINE Akrem	71kg	19 MAR 1992
	HALOUI Hemza	98kg	10 JUL 1994
ARM	- Armenia		
	GHARIBYAN Gevorg	59kg	11 DEC 1994
	ASLANYAN Karen	66kg	22 JUL 1995
	ALEKSANYAN Rafayel	71kg	24 MAY 1988
	KOCHARYAN Sargis	80kg	23 APR 1994
AZE	- Azerbaijan		
	MAMMADOV Ramiz	59kg	11 MAR 1995
	NASIBOV Samran	71kg	8 JAN 1992
	IBRAHIMLI Javid	75kg	25 MAY 1996
	HUSEYNOV Rafiq	80kg	16 MAY 1988
	ISMAYILOV Sultan	85kg	18 FEB 1992
	EYUBOV Turman	98kg	30 MAR 1994
BLR	- Belarus		
	STARADUB Siarhei	98kg	26 JUN 1991
	HRYSHCHANKA Kiryl	130kg	23 JUL 1991
BRA	- Brazil		
	RIBEIRO ROMANELLI Diego	59kg	23 MAR 1991
	MARQUES MOREIRA Angelo Rafael	75kg	12 JUL 1990
	ALBINO Davi Jose	98kg	16 DEC 1985
CHN	- China		
	YAN de	59kg	10 OCT 1991
	QING Gele	75kg	1 JAN 1993
	YAO Xiaobin	80kg	5 JUL 1992
	DAWUERJIANG Zikela	98kg	3 JUL 1986
	MULATIBIEKE Qiayisuoletan	130kg	16 JAN 1993
DOM	- Dominican Republic		
	ENCARNACION OVANDO Josue Malaquia	130kg	20 JUL 1992



MUNGYEONG KOREA 2015
6th CISM World Games

Wrestling
레슬링
Men's Greco-Roman
남자 그레고로만형



Entry List by Nation
국가별 참가인원 목록

As of FRI 9 OCT 2015

CDM	Name	Weight Category	Date of Birth
EGY	- Egypt		
	MAHMOUD Haitham	59kg	23 SEP 1991
	MOHAMED Hussein	66kg	1 SEP 1990
	ELDSOUKY Ibrahim	71kg	9 AUG 1990
	GHANEM Ibrahim	75kg	17 APR 1995
	MOHAMED Tarek	80kg	29 OCT 1993
	SAAD Ahmed	85kg	25 FEB 1989
	ABDELWAHAB Hamdy	98kg	22 JAN 1993
	MOHAMED Abdellatif	130kg	8 DEC 1995
EST	- Estonia		
	TOOTS Hardo	80kg	6 NOV 1990
	NABI Heiki	130kg	6 JUN 1985
FIN	- Finland		
	HALMESMAEKI Tero	71kg	26 SEP 1995
GEO	- Georgia		
	GIORGADZE Mirian	130kg	15 MAR 1976
GER	- Germany		
	SCHMITT Fabian	59kg	15 JUN 1992
	MENEKSE Deniz	66kg	31 MAY 1993
	EISELE Pascal	80kg	27 DEC 1992
	KUDLA Denis	85kg	24 DEC 1994
GRE	- Greece		
	PREVOLARAKIS Georgios	75kg	15 OCT 1990
	BOUKI Ilias	85kg	21 FEB 1983
IND	- India		
	SINGH Sukhvir	59kg	10 OCT 1988
	YADAV Suresh Kumar	66kg	30 JUN 1989
	YADAV Kk	71kg	10 JUL 1990
	SONU Sonu	75kg	25 APR 1993
	KHATRI Ravinder	80kg	15 MAY 1992
	SINGH Surrender	85kg	1 SEP 1988
	SUMIT Sumit	98kg	11 NOV 1994



MUNGYEONG KOREA 2015
6th CISM World Games

Wrestling
레슬링
Men's Greco-Roman
남자 그레고로만형



Entry List by Nation
국가별 참가인원 목록

As of FRI 9 OCT 2015

CDM	Name	Weight Category	Date of Birth
IRI	- Iran		
	HAJIPOUR Mohsen	59kg	29 AUG 1988
	NOROOZI Omid	66kg	18 FEB 1986
	GERAYEE Mohammadali	71kg	2 MAY 1994
	HEDAYAT Behrooz	75kg	
	KHOSRAVI Milad	80kg	15 AUG 1989
	AKHBARI Davood	85kg	18 SEP 1986
	SALEHIZADEH Seyedmostafa	98kg	6 SEP 1993
	BABAJANZADEHDARZI Bashir	130kg	20 AUG 1989
KAZ	- Kazakhstan		
	AINAGULOV Mirambek	59kg	17 FEB 1994
	ZHAKANSHA Bagylan	66kg	15 JUN 1992
	BAYAKHMETOV Darkhan	71kg	21 AUG 1985
	DILMUKHAMEDOV Askhat	80kg	26 JUL 1986
	JUMAYEV Alikhan	98kg	14 JAN 1987
KOR	- Korea, R.		
	CHOI Hyeong Muk	59kg	22 FEB 1992
	KIM Ji Hun	66kg	27 JUL 1989
	LEE Jeong Geun	71kg	26 AUG 1989
	KIM Jin Hyeok	75kg	15 MAY 1989
	KIM June Hyoung	80kg	4 AUG 1990
	LEE Se Yeol	85kg	15 OCT 1990
LIB	- Lebanon		
	SAID EI Chami	59kg	27 JUL 1986
	KAMAL EI Khatib	71kg	23 JUN 1981
	MICHEL Alsoury	80kg	24 JUN 1996
	HASSAN Hamieh	130kg	10 AUG 1993
LTU	- Lithuania		
	SLEIVA Kristupas	66kg	5 JUL 1996
	MATUZEVICIUS Julius	80kg	25 MAR 1992
	ADOMAITIS Laimutis	85kg	9 JUL 1986
	LAURINAITIS Vilius	98kg	16 JUL 1992
MGL	- Mongolia		
	BUD OCHIR Boldbaatar	80kg	7 FEB 1990
	GANBAATAR Mendbayar	85kg	20 MAY 1990
	URNUKH Zolbayar	98kg	6 DEC 1987
	LKHAGVASUREN Shinebaatar	130kg	1 JAN 1988
NGR	- Nigeria		
	OKEKE Tochukwu Micheal	75kg	8 MAR 1993



MUNGYEONG KOREA 2015
6th CISM World Games

Wrestling
레슬링
Men's Greco-Roman
남자 그레고로만형



Entry List by Nation
국가별 참가인원 목록

As of FRI 9 OCT 2015

CDM	Name	Weight Category	Date of Birth
PAK	- Pakistan		
	NADIR	66kg	29 APR 1995
	KHAN Nadir	75kg	3 JAN 1992
POL	- Poland		
	TRACZ Michal Jacek	59kg	12 JAN 1992
	KARECINSKI Dawid	66kg	10 FEB 1991
	KRACZKOWSKI Przemyslaw	71kg	26 NOV 1988
	KLIMEK Dawid Piotr	75kg	25 SEP 1995
	JANIKOWSKI Damian	85kg	27 JUN 1989
	BANAK Lukasz	130kg	4 SEP 1983
RUS	- Russia		
	KUYLAKOV Ivan	59kg	22 FEB 1986
	ALBIEV Islam Beka	66kg	28 DEC 1988
	KIIANKIN Aleksei	71kg	26 APR 1992
	ISAKOV Ruslan	75kg	28 JUL 1989
	SALEEV Evgeny	80kg	19 JAN 1989
	MISHIN Aleksei	85kg	8 FEB 1979
	MELNIKOV Nikita	98kg	27 JUN 1987
	ILNITSKII Vitalii	130kg	30 DEC 1991
SUI	- Switzerland		
DIETSCHKE Damian	75kg	27 APR 1993	
SVK	- Slovakia		
JAKUS Vojtech	71kg	27 SEP 1990	
SYR	- Syria		
	KASSAB Saleh	66kg	6 FEB 1988
	ALHAYEK Abdullah	75kg	20 JAN 1996
	HELAL Abdl Malek	85kg	15 JAN 1992
TUN	- Tunisia		
BILEL Wechtati	75kg	9 FEB 1989	
TUR	- Turkey		
	KIRAZ Kursat	59kg	4 SEP 1990
	ZURNACI Abdi	66kg	1 JAN 1992
	OZDEMIR Ahmet	71kg	5 MAY 1989
	BOZKURT Sakir	130kg	15 MAY 1989



MUNGYEONG KOREA 2015
6th CISM World Games

Wrestling
레슬링
Men's Greco-Roman
남자 그레고로만형



Entry List by Nation
국가별 참가인원 목록

As of FRI 9 OCT 2015

CDM	Name	Weight Category	Date of Birth
UKR	- Ukraine		
	MIAGKYI Ievgen	59kg	15 DEC 1985
	DEMYANKOV Denys	66kg	25 JUN 1988
	SAVCHENKO Mykola	71kg	14 AUG 1985
	PYSHKOV Dmytro	75kg	8 AUG 1986
	SHYSHMAN Oleksandr	80kg	4 JAN 1989
	BELENIUK Zhan	85kg	24 JAN 1991
	VASYLIEV Volodymyr	98kg	5 OCT 1990
	CHERNETSKYY Oleksandr	130kg	17 FEB 1984
USA	- United States of America		
	KALIL Aaron David	59kg	5 OCT 1988
	JOHNSON Jamel Rasheed	66kg	9 JUN 1991
	HOOKER Michael Joseph	71kg	28 JAN 1993
	LESTER Justin Dashaun	75kg	30 SEP 1983
	ANDERSON Jonathan Gregory	85kg	5 SEP 1984
	WILLIAMS Caylor Ryan	98kg	7 JAN 1991
	LAMB Matthew Everette	130kg	25 JUN 1973

NOTES

All corrections until the qualifications are available in INFO



MUNGYEONG KOREA 2015
6th CISM World Games

Wrestling
레슬링
Men's Freestyle
남자 자유형



Entry List by Nation
국가별 참가인원 목록

As of FRI 9 OCT 2015

CDM	Name	Weight Category	Date of Birth
ALG	- Algeria		
	SAYEH Abderrahim	61kg	21 APR 1992
	HALOUI Hemza	125kg	10 JUL 1994
ARM	- Armenia		
	GRIGORYAN Gor	57kg	23 FEB 1994
	TOROSYAN Gor	61kg	29 MAY 1996
	AVETISYAN Hakob	65kg	9 MAY 1996
	ALEKYAN Aren	70kg	20 APR 1996
AZE	- Azerbaijan		
	GASIMOV Ruslan	57kg	22 JUL 1995
	HASAN ZADA Mirjalal	61kg	18 JUL 1994
	MUSTAFAYEV Aghahuseyn	65kg	11 APR 1989
	AZIMOV Joshgun	70kg	15 OCT 1994
	YUSUBOV Ibrahim	86kg	9 APR 1991
	BAKIROV Roman	97kg	13 MAR 1989
BLR	- Belarus		
	KARPACH Andrei	70kg	6 JUN 1994
	HUSHTYN Aliaksandr	86kg	16 AUG 1993
	YANKOUSKI Ivan	97kg	25 AUG 1987
BRA	- Brazil		
	ABOU JAOUDE Adrian Antoine	86kg	11 OCT 1981
CHN	- China		
	TIAN Zhenguang	61kg	5 DEC 1993
	LI Quan	74kg	2 DEC 1983
	HUWATIBIEKE Bahetihan	86kg	5 FEB 1987
	WANG Zhengtao	97kg	15 APR 1991
	DENG Zhiwei	125kg	1 FEB 1988
EGY	- Egypt		
	ALY Ibrahim	61kg	21 MAR 1995
	MOHAMED Ibrahim	65kg	5 FEB 1990
	IBRAHIM Eyad	70kg	25 FEB 1992
	AHMED Abdou	74kg	22 FEB 1989
	MOHAMED Mohamed	86kg	31 AUG 1993
	ABDELWAHAB Hamdy	125kg	22 JAN 1993
GEO	- Georgia		
	KENKADZE Giorgi	61kg	29 OCT 1991
	JANELIDZE Revazi	65kg	28 APR 1990



MUNGYEONG KOREA 2015
6th CISM World Games

Wrestling
레슬링
Men's Freestyle
남자 자유형



Entry List by Nation
국가별 참가인원 목록

As of FRI 9 OCT 2015

CDM	Name	Weight Category	Date of Birth
GER	- Germany		
	EWALD Marcel	57kg	29 JUN 1983
	EWALD Christoph	61kg	29 JUN 1983
	HENKEL Kevin	65kg	26 NOV 1993
	MUELLER Tim	70kg	24 AUG 1991
	HARTH Georg	74kg	12 OCT 1988
	HARTH William	86kg	19 SEP 1987
	SEREGELYI Gabriel	97kg	7 NOV 1989
	KESSEL Johannes	125kg	28 OCT 1989
GRE	- Greece		
	PREVOLARAKIS Georgios	74kg	15 OCT 1990
GUI	- Guinea		
	BARRY Oumar Issa	74kg	4 SEP 1993
	SOUMAH Nfamoussa	125kg	1 JAN 1987
IND	- India		
	KADYAN Mangal	57kg	14 NOV 1996
	KUMAR Pradeep	61kg	4 AUG 1993
	RAJNEESH Rajneesh	65kg	6 SEP 1988
	KUMAR Dinesh	70kg	22 AUG 1992
	PARDEEP Pardeep	74kg	4 AUG 1993
	NAIN Karamjeet	86kg	7 MAR 1994
	YOUTHVIR Youdhvir	97kg	8 DEC 1992
	MALIK Satender	125kg	1 NOV 1992
IRI	- Iran		
	ATRANAGHARCHI Reza	57kg	8 AUG 1994
	NASIRIAFRACHALI Mehran	61kg	5 AUG 1991
	HEYDARI Meisam	65kg	22 JUN 1988
	NADERI Mohammad	70kg	8 MAY 1984
	AKBARIZARINKOLAEI Ezzatollah	74kg	11 NOV 1992
	EBRAHIMIZIVLAEI Mohammadjavad	86kg	1 NOV 1992
	ESLAMI Abazar	97kg	6 AUG 1985
	SHAMSNATERI Jafar	125kg	21 SEP 1984
KAZ	- Kazakhstan		
	KUDRIN Vladimir	57kg	7 OCT 1994
	ABIKENOV Yeldos	61kg	21 JAN 1990
	SHAGAPULY Azamat	65kg	23 FEB 1992
	SAKAYEV Azat	70kg	21 JUN 1991
	USSERBAYEV Galymzhan	74kg	19 DEC 1988
	DAVLUMBAYEV Adilet	86kg	6 FEB 1988
	JUMAYEV Alikhan	97kg	14 JAN 1987



MUNGYEONG KOREA 2015
6th CISM World Games

Wrestling
레슬링
Men's Freestyle
남자 자유형



Entry List by Nation
국가별 참가인원 목록

As of FRI 9 OCT 2015

CDM	Name	Weight Category	Date of Birth
KOR	- Korea, R.		
	KIM Jin Cheol	57kg	7 AUG 1989
	YOON Ji Hun	61kg	27 MAR 1992
	KIM Jun Chul	65kg	28 JAN 1989
	HAN Dae Su	70kg	17 DEC 1991
	LEE Yun Seok	74kg	30 DEC 1989
	KIM Gwan Uk	86kg	22 JUL 1990
	SEO Min Won	97kg	23 DEC 1991
	NAM Kyung Jin	125kg	25 AUG 1988
LAT	- Latvia		
	OZOLINS OZOLS Andris	86kg	23 DEC 1985
LIB	- Lebanon		
	SAID EI Chami	57kg	27 JUL 1986
	KAMAL EI Khatib	70kg	23 JUN 1981
	MICHEL Alsoury	86kg	24 JUN 1996
	HASSAN Hamieh	125kg	10 AUG 1993
MGL	- Mongolia		
	DAMDINBAZAR Tsogtbaatar	57kg	2 JAN 1988
	BYAMBADORJ Khash Erdene	61kg	24 JUL 1992
	BATCHULUUN Batmagnai	65kg	23 JUL 1989
	GANZORIG Mandakhnaran	70kg	11 MAY 1986
	BAT ERDENE Byambadorj	74kg	27 JUL 1996
	ORGODOL Uitumen	86kg	29 APR 1989
	DORJKHAND Khuderbulga	97kg	7 MAY 1992
	CHOIJILSUREN Munkhtogtokh	125kg	17 JUN 1988
MKD	- FYROM		
	GEORGIEV Ile	65kg	10 JAN 1981
NGR	- Nigeria		
	CLEMENT Solikume Koffi	61kg	9 AUG 1983
PAK	- Pakistan		
	HUSSAIN Azhar	57kg	15 MAR 1984
	NADIR	61kg	29 APR 1995
	KHAN Nadir	70kg	3 JAN 1992
POL	- Poland		
	STATKIEWICZ Rafal	65kg	5 JAN 1991
	BRZOZOWSKI Krystian	74kg	20 FEB 1982
	BALAWENDER Maciej Michal	125kg	7 FEB 1988



MUNGYEONG KOREA 2015
6th CISM World Games

Wrestling
레슬링
Men's Freestyle
남자 자유형



Entry List by Nation
국가별 참가인원 목록

As of FRI 9 OCT 2015

CDM	Name	Weight Category	Date of Birth
RUS	- Russia		
	TUSKAEV Azamat	57kg	21 JAN 1994
	OTARSULTANOV Dzhamal	61kg	14 APR 1987
	KVRBANALIEV Magomed	65kg	
	RAMONOV Soslan	70kg	1 JAN 1991
	TCABOLOV Khetik	74kg	17 NOV 1991
	KUDIIMAGOMEDOV Shamil	86kg	9 MAY 1993
	GATCALOV Khadzhimurot	97kg	
	BAITCAEV Vladislav	125kg	17 AUG 1988
SUI	- Switzerland		
	VOCK Randy Adrian	61kg	1 MAR 1994
	RIESEN Marco Lukas	86kg	22 OCT 1987
SYR	- Syria		
	HELAL Abdl Malek	86kg	15 JAN 1992
TUN	- Tunisia		
	BILEL Wechtati	74kg	9 FEB 1989
TUR	- Turkey		
	ZURNACI Abdi	61kg	1 JAN 1992
	KIRAZ Kursat	65kg	4 SEP 1990
	OZDEMIR Ahmet	74kg	5 MAY 1989
	BOZKURT Sakir	125kg	15 MAY 1989
UAE	- United Arab Emirates		
	ALQUBAISI Saeed	70kg	25 JUL 1985
	ALQUBAISI Mohamed	74kg	22 JUN 1985
	GHAILANI Jasem	86kg	3 JAN 1995
UKR	- Ukraine		
	AIVAZIAN Mykola	61kg	10 JUL 1989
	SHUPTAR Vasyl	65kg	27 JAN 1991
	KHAIVILOV Yevhenii	70kg	24 MAR 1981
	ZAKHAREVYCH Oleg	74kg	9 JUL 1990
	BILOTSERKIVSKYI Oleh	86kg	13 MAY 1983
	OLIINYK Pavlo	97kg	21 FEB 1989
	KUCHMII Mykola	125kg	28 FEB 1992



MUNGYEONG KOREA 2015
6th CISM World Games

Wrestling
레슬링
Men's Freestyle
남자 자유형



Entry List by Nation
국가별 참가인원 목록

As of FRI 9 OCT 2015

CDM	Name	Weight Category	Date of Birth
USA	- United States of America		
	NOWRY Max Emiliano	57kg	16 MAR 1990
	SIMPSON William Christopher	61kg	29 AUG 1985
	von OHLEN Cole Landon	65kg	6 JAN 1990
	HOOKER Michael Joseph	70kg	28 JAN 1993
	DOMBROVSKYY Valdyslav	74kg	23 MAY 1990
	TERRELL II Victor Wesley	86kg	28 MAY 1988
	MEZA Endhyr	97kg	19 JAN 1992

NOTES

All corrections until the qualifications are available in INFO



MUNGYEONG KOREA 2015
6th CISM World Games

Wrestling

레슬링

Men's Greco-Roman 59kg

남자 그레코로만형 59kg



Entry List by Weight Category

체급별 참가인원 목록

As of FRI 9 OCT 2015

Nation	Name	Date of Birth	Qualified
ARM - Armenia	GHARIBYAN Gevorg	11 DEC 1994	
AZE - Azerbaijan	MAMMADOV Ramiz	11 MAR 1995	
BRA - Brazil	RIBEIRO ROMANELLI Diego	23 MAR 1991	
CHN - China	YAN de	10 OCT 1991	
EGY - Egypt	MAHMOUD Haitham	23 SEP 1991	
GER - Germany	SCHMITT Fabian	15 JUN 1992	
IND - India	SINGH Sukhvir	10 OCT 1988	
IRI - Iran	HAJIPOUR Mohsen	29 AUG 1988	
KAZ - Kazakhstan	AINAGULOV Mirambek	17 FEB 1994	
KOR - Korea, R.	CHOI Hyeong Muk	22 FEB 1992	
LIB - Lebanon	SAID El Chami	27 JUL 1986	
POL - Poland	TRACZ Michal Jacek	12 JAN 1992	
RUS - Russia	KUYLAKOV Ivan	22 FEB 1986	
TUR - Turkey	KIRAZ Kursat	4 SEP 1990	
UKR - Ukraine	MIAGKYI Ievgen	15 DEC 1985	
USA - United States of America	KALIL Aaron David	5 OCT 1988	

Total: 16 wrestlers

NOTES

All changes are available in INFO



MUNGYEONG KOREA 2015
6th CISM World Games

Wrestling

레슬링

Men's Greco-Roman 66kg

남자 그레고로만형 66kg



Entry List by Weight Category

체급별 참가인원 목록

As of FRI 9 OCT 2015

Nation	Name	Date of Birth	Qualified
ALG - Algeria	BENAISSA Tarek Aziz	7 APR 1991	
ARM - Armenia	ASLANYAN Karen	22 JUL 1995	
EGY - Egypt	MOHAMED Hussein	1 SEP 1990	
GER - Germany	MENEKSE Deniz	31 MAY 1993	
IND - India	YADAV Suresh Kumar	30 JUN 1989	
IRI - Iran	NOROOZI Omid	18 FEB 1986	
KAZ - Kazakhstan	ZHAKANSHA Bagylan	15 JUN 1992	
KOR - Korea, R.	KIM Ji Hun	27 JUL 1989	
LTU - Lithuania	SLEIVA Kristupas	5 JUL 1996	
PAK - Pakistan	NADIR	29 APR 1995	
POL - Poland	KARECINSKI Dawid	10 FEB 1991	
RUS - Russia	ALBIEV Islam Beka	28 DEC 1988	
SYR - Syria	KASSAB Saleh	6 FEB 1988	
TUR - Turkey	ZURNACI Abdi	1 JAN 1992	
UKR - Ukraine	DEMYANKOV Denys	25 JUN 1988	
USA - United States of America	JOHNSON Jamel Rasheed	9 JUN 1991	

Total: 16 wrestlers

NOTES

All changes are available in INFO



MUNGYEONG KOREA 2015
6th CISM World Games

Wrestling

레슬링

Men's Greco-Roman 71kg

남자 그레고로만형 71kg



Entry List by Weight Category

체급별 참가인원 목록

As of FRI 9 OCT 2015

Nation	Name	Date of Birth	Qualified
ALG - Algeria	BOUDJEMLINE Akrem	19 MAR 1992	
ARM - Armenia	ALEKSANYAN Rafayel	24 MAY 1988	
AZE - Azerbaijan	NASIBOV Samran	8 JAN 1992	
EGY - Egypt	ELDSOUKY Ibrahim	9 AUG 1990	
FIN - Finland	HALMESMAEKI Tero	26 SEP 1995	
IND - India	YADAV Kk	10 JUL 1990	
IRI - Iran	GERAYEE Mohammadali	2 MAY 1994	
KAZ - Kazakhstan	BAYAKHMETOV Darkhan	21 AUG 1985	
KOR - Korea, R.	LEE Jeong Geun	26 AUG 1989	
LIB - Lebanon	KAMAL El Khatib	23 JUN 1981	
POL - Poland	KRACZKOWSKI Przemyslaw	26 NOV 1988	
RUS - Russia	KIIANKIN Aleksei	26 APR 1992	
SVK - Slovakia	JAKUS Vojtech	27 SEP 1990	
TUR - Turkey	OZDEMIR Ahmet	5 MAY 1989	
UKR - Ukraine	SAVCHENKO Mykola	14 AUG 1985	
USA - United States of America	HOOKER Michael Joseph	28 JAN 1993	

Total: 16 wrestlers

NOTES

All changes are available in INFO



MUNGYEONG KOREA 2015
6th CISM World Games

Wrestling

레슬링

Men's Greco-Roman 75kg

남자 그레고로만형 75kg



Entry List by Weight Category

체급별 참가인원 목록

As of FRI 9 OCT 2015

Nation	Name	Date of Birth	Qualified
AZE - Azerbaijan	IBRAHIMLI Javid	25 MAY 1996	
BRA - Brazil	MARQUES MOREIRA Angelo Rafael	12 JUL 1990	
CHN - China	QING Gele	1 JAN 1993	
EGY - Egypt	GHANEM Ibrahim	17 APR 1995	
GRE - Greece	PREVOLARAKIS Georgios	15 OCT 1990	
IND - India	SONU Sonu	25 APR 1993	
IRI - Iran	HEDAYAT Behrooz		
KOR - Korea, R.	KIM Jin Hyeok	15 MAY 1989	
NGR - Nigeria	OKEKE Tochukwu Micheal	8 MAR 1993	
PAK - Pakistan	KHAN Nadir	3 JAN 1992	
POL - Poland	KLIMEK Dawid Piotr	25 SEP 1995	
RUS - Russia	ISAKOV Ruslan	28 JUL 1989	
SUI - Switzerland	DIETSCHKE Damian	27 APR 1993	
SYR - Syria	ALHAYEK Abdullah	20 JAN 1996	
TUN - Tunisia	BILEL Wechtati	9 FEB 1989	
UKR - Ukraine	PYSHKOV Dmytro	8 AUG 1986	
USA - United States of America	LESTER Justin Dashaun	30 SEP 1983	

Total: 17 wrestlers

NOTES

All changes are available in INFO



MUNGYEONG KOREA 2015
6th CISM World Games

Wrestling

레슬링

Men's Greco-Roman 80kg

남자 그레고로만형 80kg



Entry List by Weight Category

체급별 참가인원 목록

As of FRI 9 OCT 2015

Nation	Name	Date of Birth	Qualified
ARM - Armenia	KOCHARYAN Sargis	23 APR 1994	
AZE - Azerbaijan	HUSEYNOV Rafiq	16 MAY 1988	
CHN - China	YAO Xiaobin	5 JUL 1992	
EGY - Egypt	MOHAMED Tarek	29 OCT 1993	
EST - Estonia	TOOTS Hardo	6 NOV 1990	
GER - Germany	EISELE Pascal	27 DEC 1992	
IND - India	KHATRI Ravinder	15 MAY 1992	
IRI - Iran	KHOSRAVI Milad	15 AUG 1989	
KAZ - Kazakhstan	DILMUKHAMEDOV Askhat	26 JUL 1986	
KOR - Korea, R.	KIM June Hyoung	4 AUG 1990	
LIB - Lebanon	MICHEL Alsoury	24 JUN 1996	
LTU - Lithuania	MATUZEVICIUS Julius	25 MAR 1992	
MGL - Mongolia	BUD OCHIR Boldbaatar	7 FEB 1990	
RUS - Russia	SALEEV Evgeny	19 JAN 1989	
UKR - Ukraine	SHYSHMAN Oleksandr	4 JAN 1989	

Total: 15 wrestlers

NOTES

All changes are available in INFO



MUNGYEONG KOREA 2015
6th CISM World Games

Wrestling

레슬링

Men's Greco-Roman 85kg

남자 그레고로만형 85kg



Entry List by Weight Category

체급별 참가인원 목록

As of FRI 9 OCT 2015

Nation	Name	Date of Birth	Qualified
AZE - Azerbaijan	ISMAYILOV Sultan	18 FEB 1992	
EGY - Egypt	SAAD Ahmed	25 FEB 1989	
GER - Germany	KUDLA Denis	24 DEC 1994	
GRE - Greece	BOUKI Ilias	21 FEB 1983	
IND - India	SINGH Surender	1 SEP 1988	
IRI - Iran	AKHBARI Davood	18 SEP 1986	
KOR - Korea, R.	LEE Se Yeol	15 OCT 1990	
LTU - Lithuania	ADOMAITIS Laimutis	9 JUL 1986	
MGL - Mongolia	GANBAATAR Mendbayar	20 MAY 1990	
POL - Poland	JANIKOWSKI Damian	27 JUN 1989	
RUS - Russia	MISHIN Aleksei	8 FEB 1979	
SYR - Syria	HELAL Abdl Malek	15 JAN 1992	
UKR - Ukraine	BELENIUK Zhan	24 JAN 1991	
USA - United States of America	ANDERSON Jonathan Gregory	5 SEP 1984	

Total: 14 wrestlers

NOTES

All changes are available in INFO



MUNGYEONG KOREA 2015
6th CISM World Games

Wrestling

레슬링

Men's Greco-Roman 98kg

남자 그레고로만형 98kg



Entry List by Weight Category

체급별 참가인원 목록

As of FRI 9 OCT 2015

Nation	Name	Date of Birth	Qualified
ALG - Algeria	HALOUI Hemza	10 JUL 1994	
AZE - Azerbaijan	EYUBOV Turman	30 MAR 1994	
BLR - Belarus	STARADUB Siarhei	26 JUN 1991	
BRA - Brazil	ALBINO Davi Jose	16 DEC 1985	
CHN - China	DAWUERJIANG Zikela	3 JUL 1986	
EGY - Egypt	ABDELWAHAB Hamdy	22 JAN 1993	
IND - India	SUMIT Sumit	11 NOV 1994	
IRI - Iran	SALEHIZADEH Seyedmostafa	6 SEP 1993	
KAZ - Kazakhstan	JUMAYEV Alikhan	14 JAN 1987	
LTU - Lithuania	LAURINAITIS Vilius	16 JUL 1992	
MGL - Mongolia	URNUKH Zolbayar	6 DEC 1987	
RUS - Russia	MELNIKOV Nikita	27 JUN 1987	
UKR - Ukraine	VASYLIEV Volodymyr	5 OCT 1990	
USA - United States of America	WILLIAMS Caylor Ryan	7 JAN 1991	

Total: 14 wrestlers

NOTES

All changes are available in INFO



MUNGYEONG KOREA 2015
6th CISM World Games

Wrestling

레슬링

Men's Greco-Roman 130kg

남자 그레고로만형 130kg



Entry List by Weight Category

체급별 참가인원 목록

As of FRI 9 OCT 2015

Nation	Name	Date of Birth	Qualified
BLR - Belarus	HRYSHCHANKA Kiryl	23 JUL 1991	
CHN - China	MULATIBIEKE Qiayisuoletan	16 JAN 1993	
DOM - Dominican Republic	ENCARNACION OVANDO Josue Malaquia	20 JUL 1992	
EGY - Egypt	MOHAMED Abdellatif	8 DEC 1995	
EST - Estonia	NABI Heiki	6 JUN 1985	
GEO - Georgia	GIORGADZE Mirian	15 MAR 1976	
IRI - Iran	BABAJANZADEHDARZI Bashir	20 AUG 1989	
LIB - Lebanon	HASSAN Hamieh	10 AUG 1993	
MGL - Mongolia	LKHAGVASUREN Shinebaatar	1 JAN 1988	
POL - Poland	BANAK Lukasz	4 SEP 1983	
RUS - Russia	ILNITSKII Vitalii	30 DEC 1991	
TUR - Turkey	BOZKURT Sakir	15 MAY 1989	
UKR - Ukraine	CHERNETSKYY Oleksandr	17 FEB 1984	
USA - United States of America	LAMB Matthew Everette	25 JUN 1973	

Total: 14 wrestlers

NOTES

All changes are available in INFO



MUNGYEONG KOREA 2015
6th CISM World Games

Wrestling

레슬링

Men's Freestyle 57kg

남자 자유형 57kg



Entry List by Weight Category

체급별 참가인원 목록

As of FRI 9 OCT 2015

Nation	Name	Date of Birth	Qualified
ARM - Armenia	GRIGORYAN Gor	23 FEB 1994	
AZE - Azerbaijan	GASIMOV Ruslan	22 JUL 1995	
GER - Germany	EWALD Marcel	29 JUN 1983	
IND - India	KADYAN Mangal	14 NOV 1996	
IRI - Iran	ATRANAGHARCHI Reza	8 AUG 1994	
KAZ - Kazakhstan	KUDRIN Vladimir	7 OCT 1994	
KOR - Korea, R.	KIM Jin Cheol	7 AUG 1989	
LIB - Lebanon	SAID El Chami	27 JUL 1986	
MGL - Mongolia	DAMDINBAZAR Tsogtbaatar	2 JAN 1988	
PAK - Pakistan	HUSSAIN Azhar	15 MAR 1984	
RUS - Russia	TUSKAEV Azamat	21 JAN 1994	
USA - United States of America	NOWRY Max Emiliano	16 MAR 1990	

Total: 12 wrestlers

NOTES

All changes are available in INFO



MUNGYEONG KOREA 2015
6th CISM World Games

Wrestling

레슬링

Men's Freestyle 61kg

남자 자유형 61kg



Entry List by Weight Category

체급별 참가인원 목록

As of FRI 9 OCT 2015

Nation	Name	Date of Birth	Qualified
ALG - Algeria	SAYEH Abderrahim	21 APR 1992	
ARM - Armenia	TOROSYAN Gor	29 MAY 1996	
AZE - Azerbaijan	HASAN ZADA Mirjalal	18 JUL 1994	
CHN - China	TIAN Zhenguang	5 DEC 1993	
EGY - Egypt	ALY Ibrahim	21 MAR 1995	
GEO - Georgia	KENKADZE Giorgi	29 OCT 1991	
GER - Germany	EWALD Christoph	29 JUN 1983	
IND - India	KUMAR Pradeep	4 AUG 1993	
IRI - Iran	NASIRIAFRACHALI Mehran	5 AUG 1991	
KAZ - Kazakhstan	ABIKENOV Yeldos	21 JAN 1990	
KOR - Korea, R.	YOON Ji Hun	27 MAR 1992	
MGL - Mongolia	BYAMBADORJ Khash Erdene	24 JUL 1992	
NGR - Nigeria	CLEMENT Solikume Koffi	9 AUG 1983	
PAK - Pakistan	NADIR	29 APR 1995	
RUS - Russia	OTARSULTANOV Dzhamal	14 APR 1987	
SUI - Switzerland	VOCK Randy Adrian	1 MAR 1994	
TUR - Turkey	ZURNACI Abdi	1 JAN 1992	
UKR - Ukraine	AIVAZIAN Mykola	10 JUL 1989	
USA - United States of America	SIMPSON William Christoper	29 AUG 1985	

Total: 19 wrestlers

NOTES

All changes are available in INFO



MUNGYEONG KOREA 2015
6th CISM World Games

Wrestling

레슬링

Men's Freestyle 65kg

남자 자유형 65kg



Entry List by Weight Category

체급별 참가인원 목록

As of FRI 9 OCT 2015

Nation	Name	Date of Birth	Qualified
ARM - Armenia	AVETISYAN Hakob	9 MAY 1996	
AZE - Azerbaijan	MUSTAFAYEV Aghahuseyn	11 APR 1989	
EGY - Egypt	MOHAMED Ibrahim	5 FEB 1990	
GEO - Georgia	JANELIDZE Revazi	28 APR 1990	
GER - Germany	HENKEL Kevin	26 NOV 1993	
IND - India	RAJNEESH Rajneesh	6 SEP 1988	
IRI - Iran	HEYDARI Meisam	22 JUN 1988	
KAZ - Kazakhstan	SHAGAPULY Azamat	23 FEB 1992	
KOR - Korea, R.	KIM Jun Chul	28 JAN 1989	
MGL - Mongolia	BATCHULUUN Batmagnai	23 JUL 1989	
MKD - FYROM	GEORGIEV Ile	10 JAN 1981	
POL - Poland	STATKIEWICZ Rafal	5 JAN 1991	
RUS - Russia	KVRBANALIEV Magomed		
TUR - Turkey	KIRAZ Kursat	4 SEP 1990	
UKR - Ukraine	SHUPTAR Vasyi	27 JAN 1991	
USA - United States of America	von OHLEN Cole Landon	6 JAN 1990	

Total: 16 wrestlers

NOTES

All changes are available in INFO



MUNGYEONG KOREA 2015
6th CISM World Games

Wrestling

레슬링

Men's Freestyle 70kg

남자 자유형 70kg



Entry List by Weight Category

체급별 참가인원 목록

As of FRI 9 OCT 2015

Nation	Name	Date of Birth	Qualified
ARM - Armenia	ALEKYAN Aren	20 APR 1996	
AZE - Azerbaijan	AZIMOV Joshgun	15 OCT 1994	
BLR - Belarus	KARPACH Andrei	6 JUN 1994	
EGY - Egypt	IBRAHIM Eyad	25 FEB 1992	
GER - Germany	MUELLER Tim	24 AUG 1991	
IND - India	KUMAR Dinesh	22 AUG 1992	
IRI - Iran	NADERI Mohammad	8 MAY 1984	
KAZ - Kazakhstan	SAKAYEV Azat	21 JUN 1991	
KOR - Korea, R.	HAN Dae Su	17 DEC 1991	
LIB - Lebanon	KAMAL El Khatib	23 JUN 1981	
MGL - Mongolia	GANZORIG Mandakhnaran	11 MAY 1986	
PAK - Pakistan	KHAN Nadir	3 JAN 1992	
RUS - Russia	RAMONOV Soslan	1 JAN 1991	
UAE - United Arab Emirates	ALQUBAISI Saeed	25 JUL 1985	
UKR - Ukraine	KHAVILOV Yevhenii	24 MAR 1981	
USA - United States of America	HOOKER Michael Joseph	28 JAN 1993	

Total: 16 wrestlers

NOTES

All changes are available in INFO



MUNGYEONG KOREA 2015
6th CISM World Games

Wrestling

레슬링

Men's Freestyle 74kg

남자 자유형 74kg



Entry List by Weight Category

체급별 참가인원 목록

As of FRI 9 OCT 2015

Nation	Name	Date of Birth	Qualified
CHN - China	LI Quan	2 DEC 1983	
EGY - Egypt	AHMED Abdou	22 FEB 1989	
GER - Germany	HARTH Georg	12 OCT 1988	
GRE - Greece	PREVOLARAKIS Georgios	15 OCT 1990	
GUI - Guinea	BARRY Oumar Issa	4 SEP 1993	
IND - India	PARDEEP Pardeep	4 AUG 1993	
IRI - Iran	AKBARIZARINKOLAEI Ezzatollah	11 NOV 1992	
KAZ - Kazakhstan	USSERBAYEV Galymzhan	19 DEC 1988	
KOR - Korea, R.	LEE Yun Seok	30 DEC 1989	
MGL - Mongolia	BAT ERDENE Byambadorj	27 JUL 1996	
POL - Poland	BRZOZOWSKI Krystian	20 FEB 1982	
RUS - Russia	TCABOLOV Khetik	17 NOV 1991	
TUN - Tunisia	BILEL Wechtati	9 FEB 1989	
TUR - Turkey	OZDEMIR Ahmet	5 MAY 1989	
UAE - United Arab Emirates	ALQUBAISI Mohamed	22 JUN 1985	
UKR - Ukraine	ZAKHAREVYCH Oleg	9 JUL 1990	
USA - United States of America	DOMBROVSKYY Valdyslav	23 MAY 1990	

Total: 17 wrestlers

NOTES

All changes are available in INFO



MUNGYEONG KOREA 2015
6th CISM World Games

Wrestling

레슬링

Men's Freestyle 86kg

남자 자유형 86kg



Entry List by Weight Category

체급별 참가인원 목록

As of FRI 9 OCT 2015

Nation	Name	Date of Birth	Qualified
AZE - Azerbaijan	YUSUBOV Ibrahim	9 APR 1991	
BLR - Belarus	HUSHTYN Aliaksandr	16 AUG 1993	
BRA - Brazil	ABOU JAOUDE Adrian Antoine	11 OCT 1981	
CHN - China	HUWATIBIEKE Bahetihan	5 FEB 1987	
EGY - Egypt	MOHAMED Mohamed	31 AUG 1993	
GER - Germany	HARTH William	19 SEP 1987	
IND - India	NAIN Karamjeet	7 MAR 1994	
IRI - Iran	EBRAHIMIZIVLAEI Mohammadjavad	1 NOV 1992	
KAZ - Kazakhstan	DAVLUMBAYEV Adilet	6 FEB 1988	
KOR - Korea, R.	KIM Gwan Uk	22 JUL 1990	
LAT - Latvia	OZOLINS OZOLS Andris	23 DEC 1985	
LIB - Lebanon	MICHEL Alsoury	24 JUN 1996	
MGL - Mongolia	ORGODOL Uitumen	29 APR 1989	
RUS - Russia	KUDIIMAGOMEDOV Shamil	9 MAY 1993	
SUI - Switzerland	RIESEN Marco Lukas	22 OCT 1987	
SYR - Syria	HELAL Abdl Malek	15 JAN 1992	
UAE - United Arab Emirates	GHAILANI Jasem	3 JAN 1995	
UKR - Ukraine	BILOTSERKIVSKYI Oleh	13 MAY 1983	
USA - United States of America	TERRELL II Victor Wesley	28 MAY 1988	

Total: 19 wrestlers

NOTES

All changes are available in INFO



MUNGYEONG KOREA 2015
6th CISM World Games

Wrestling

레슬링

Men's Freestyle 97kg

남자 자유형 97kg



Entry List by Weight Category

체급별 참가인원 목록

As of FRI 9 OCT 2015

Nation	Name	Date of Birth	Qualified
AZE - Azerbaijan	BAKIROV Roman	13 MAR 1989	
BLR - Belarus	YANKOUSKI Ivan	25 AUG 1987	
CHN - China	WANG Zhengtao	15 APR 1991	
GER - Germany	SEREGELYI Gabriel	7 NOV 1989	
IND - India	YODHVIR Youdhvir	8 DEC 1992	
IRI - Iran	ESLAMI Abazar	6 AUG 1985	
KAZ - Kazakhstan	JUMAYEV Alikhan	14 JAN 1987	
KOR - Korea, R.	SEO Min Won	23 DEC 1991	
MGL - Mongolia	DORJKHAND Khuderbulga	7 MAY 1992	
RUS - Russia	GATCALOV Khadzhimurot		
UKR - Ukraine	OLIINYK Pavlo	21 FEB 1989	
USA - United States of America	MEZA Endhyr	19 JAN 1992	

Total: 12 wrestlers

NOTES

All changes are available in INFO



MUNGYEONG KOREA 2015
6th CISM World Games

Wrestling

레슬링

Men's Freestyle 125kg

남자 자유형 125kg



Entry List by Weight Category

체급별 참가인원 목록

As of FRI 9 OCT 2015

Nation	Name	Date of Birth	Qualified
ALG - Algeria	HALOUI Hemza	10 JUL 1994	
CHN - China	DENG Zhiwei	1 FEB 1988	
EGY - Egypt	ABDELWAHAB Hamdy	22 JAN 1993	
GER - Germany	KESSEL Johannes	28 OCT 1989	
GUI - Guinea	SOUMAH Nfamoussa	1 JAN 1987	
IND - India	MALIK Satender	1 NOV 1992	
IRI - Iran	SHAMSNATERI Jafar	21 SEP 1984	
KOR - Korea, R.	NAM Kyung Jin	25 AUG 1988	
LIB - Lebanon	HASSAN Hamieh	10 AUG 1993	
MGL - Mongolia	CHOIJILSUREN Munkhtogtokh	17 JUN 1988	
POL - Poland	BALAWENDER Maciej Michal	7 FEB 1988	
RUS - Russia	BAITCAEV Vladislav	17 AUG 1988	
TUR - Turkey	BOZKURT Sakir	15 MAY 1989	
UKR - Ukraine	KUCHMII Mykola	28 FEB 1992	

Total: 14 wrestlers

NOTES

All changes are available in INFO



Competition Sheet

체급별 대진 정보

1/8 FINALS				1/4 FINALS				SEMIFINALS				FINAL																																											
1	4/9	SCHMITT F	GER	P1	P2	7	2	1	1	2	GER	P1	P2	2	0	3	0	0	KOR	P1	P2	0	0	6	4	8	KAZ	P1	P2	8	0	6	GOLD				6	AINAGULOV M	KAZ																
2	1/1	SINGH S	IND	P1	P2	1	0		3	4	10	KOR	P1	P2	8		2	6	3	8	KAZ	P1	P2		0	8	6	4	9	KAZ	P1		P2	0	9	CLASSIFICATION	1	AINAGULOV M	KAZ																
3	4/9	CHOI HM	KOR	P1	P2	1	8	6	3	8	KAZ	P1	P2	0	8		12		3	8	EGY	P1	P2		2	6		5	5	KIRAZ K	TUR																								
4	0/0	KALIL AD	USA	P1	P2	0	0	8	1	2	TUR	P1	P2	0	2			12	0	0	EGY	P1	P2		0	0	8		8	TRACZ MJ	POL																								
5	0/0	MAMMADOV R	AZE	P1	P2	0	0	10	1	4	IRI	P1	P2	2	2	14	1		6	RUS	P1	P2	6		0	9			9	MIAGKYI I	UKR																								
6	4/9	AINAGULOV M	KAZ	P1	P2	9	0	12	3	6	EGY	P1	P2	0	6		14	3	3	RUS	P1	P2	0		3				10	10	MAMMADOV R		AZE																						
7	1/7	MIAGKYI I	UKR	P1	P2	3	4	14	3	3	RUS	P1	P2	0	3	16		0	0	POL	P1	P2	0		0					11	11		YAN D	CHN																					
8	3/9	KIRAZ K	TUR	P1	P2	9	0	16	0	0	POL	P1	P2	0	0		16	3	4	TRACZ MJ	POL	P1	P2		0						4		12	12	SINGH S		IND																		
9	0/0	RIBEIRO ROMANELLI	BRA	P1	P2	0	0	10	1	4	IRI	P1	P2	2	2	16		0	0	LIB	P1	P2	0		0						13			13	GHARIBYAN G		ARM																		
10	4/9	HAJIPOUR M	IRI	P1	P2	5	4	14	3	3	RUS	P1	P2	0	3		16	4	8	IRI	P1	P2	8		0									14	14		KALIL AD	USA																	
11	0/0	SAID EC	LIB	P1	P2	0	0	14	1	6	RUS	P1	P2	6	0	16		0	0	EGY	P1	P2	0		0										15		15	YAN D	CHN																
12	4/8	MAHMOUD H	EGY	P1	P2	8	0	16	0	0	POL	P1	P2	0	0		16	3	4	TRACZ MJ	POL	P1	P2		0												4	16	16	SAID EC	LIB														
13	0/0	GHARIBYAN G	ARM	P1	P2	0	0	14	3	3	RUS	P1	P2	0	3	16		0	0	LIB	P1	P2	0	0	REPECHAGE												16		SAID EC	LIB															
14	3/7	KUYLAKOV I	RUS	P1	P2	6	1	14	1	6	RUS	P1	P2	6	0		16	0	0	LIB	P1	P2	0	0												UPPER BRANCH	5		1	4	AZE	P1	P2	4	0	8	0	0	TUR	P1	P2	0	0	3	3
15	1/2	YAN D	CHN	P1	P2	2	0	8	3	6	TUR	P1	P2	2	4	3		4	9	KOR	P1	P2	9	0				LOWER BRANCH									11		0	0	LIB	P1	P2	0	0		10	4	8	IRI	P1	P2	8		0
16	3/4	TRACZ MJ	POL	P1	P2	0	4	10	4	8	IRI	P1	P2	8	0		14	0	0	RUS	P1	P2	0	0			BRONZE										14		0	0	RUS	P1	P2	0	0										



Competition Sheet

체급별 대진 정보

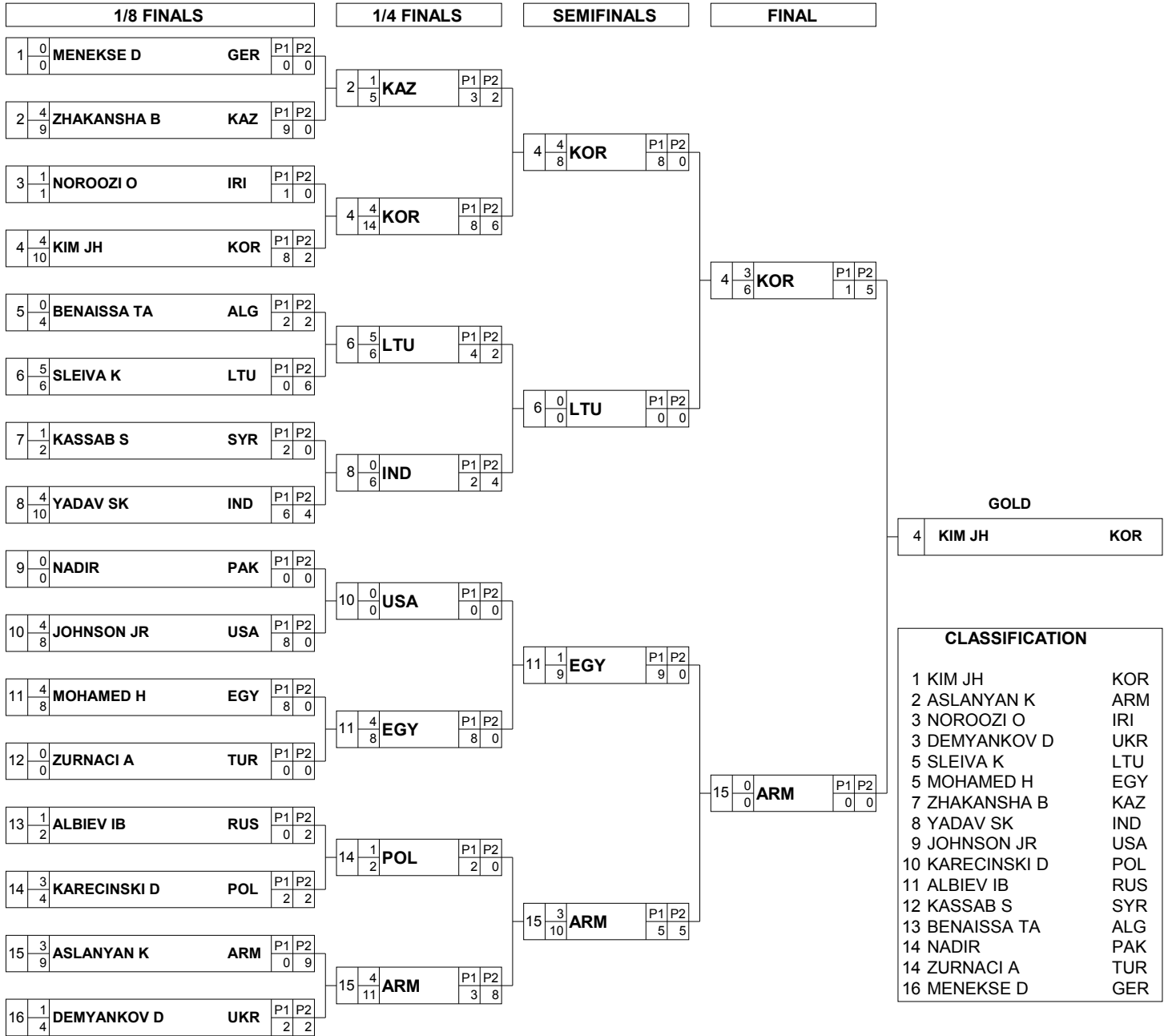



Competition Sheet

체급별 대진 정보



CLASSIFICATION		
1	GERAYEE M	IRI
2	LEE JG	KOR
3	SAVCHENKO M	UKR
3	ELDSOUKY I	EGY
5	HALMESMAEKI T	FIN
5	ALEKSANYAN R	ARM
7	BAYAKHMETOV D	KAZ
8	KRACZKOWSKI P	POL
9	KIIANKIN A	RUS
10	JAKUS V	SVK
11	YADAV K	IND
12	BOUDJEMPLINE A	ALG
13	HOOKEER MJ	USA
14	KAMAL EK	LIB
14	NASIBOV S	AZE
16	OZDEMIR A	TUR

REPECHAGE

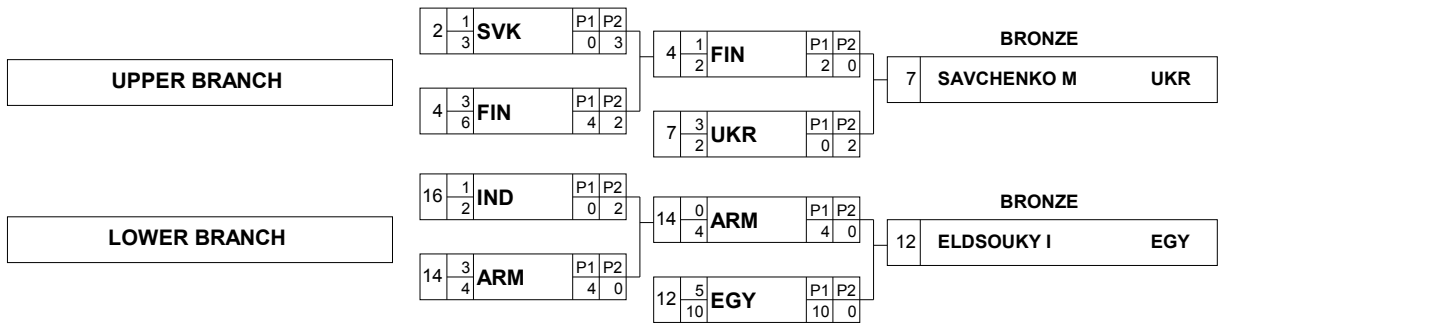



Competition Sheet

체급별 대진 정보

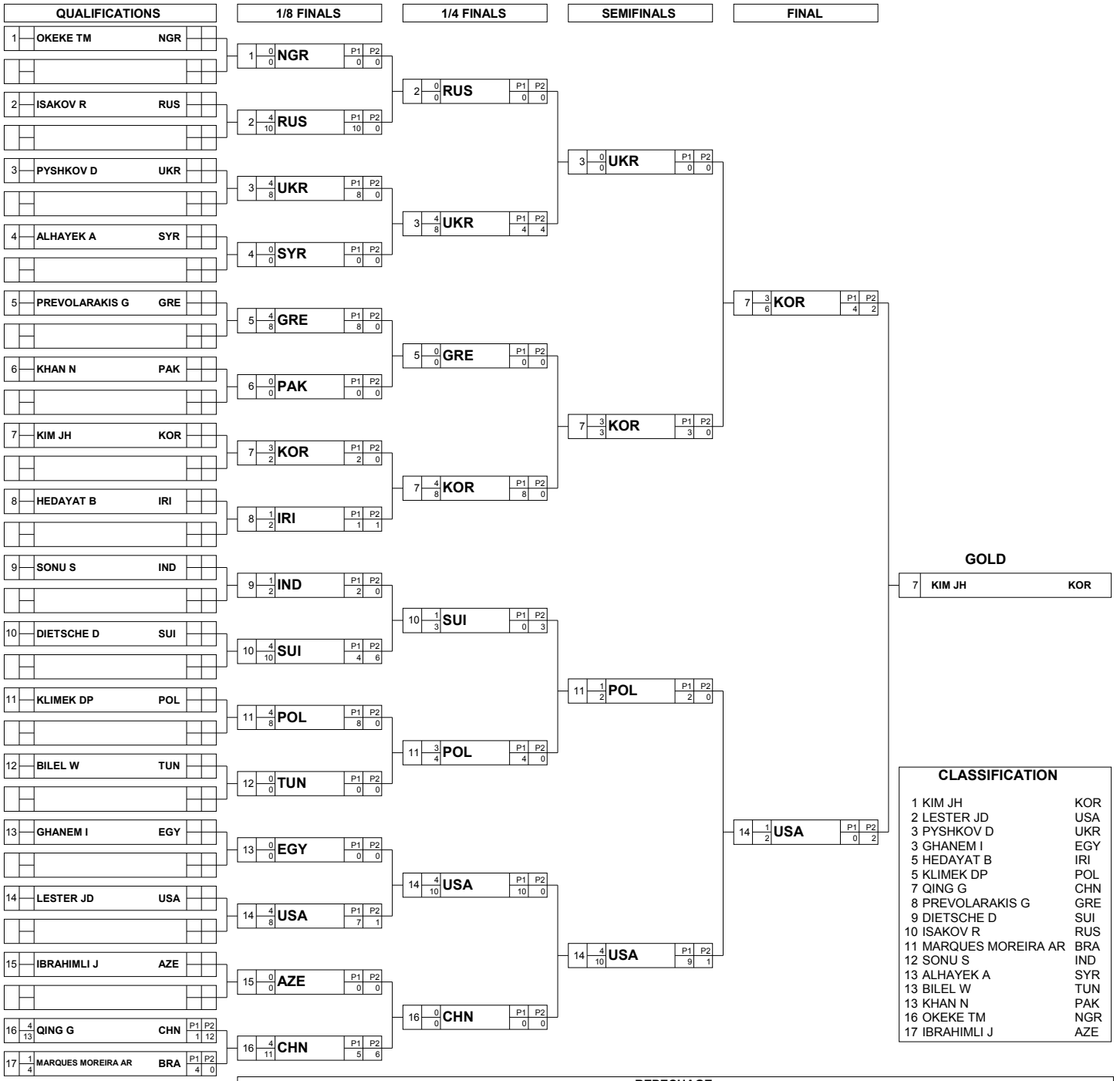



Competition Sheet

체급별 대진 정보

QUALIFICATIONS	1/4 FINALS	SEMIFINALS	FINAL
1 KHATRI R IND	1 0 IND P1 P2 0 0	2 1 KAZ P1 P2 1 0 1	4 0 RUS P1 P2 2 2 0
2 5 DILMUKHAMEDOV A KAZ P1 P2 13 9 4	2 4 KAZ P1 P2 9 0	4 3 RUS P1 P2 2 0 2	10 HUSEYNOV R AZE
3 0 YAO X CHN P1 P2 13 9 4	4 3 RUS P1 P2 8 4 4	10 3 AZE P1 P2 4 2 2	CLASSIFICATION 1 HUSEYNOV R AZE 2 SALEEV E RUS 3 SHYSHMAN O UKR 3 KOCHARYAN S ARM 5 DILMUKHAMEDOV A KAZ 5 MATUZEVICIUS J LTU 7 KIM JH KOR 8 MOHAMED T EGY 9 TOOTS H EST 10 KHOSRAVI M IRI 11 YAO X CHN 12 EISELE P GER 13 BUD OCHIR B MGL 13 MICHEL A LIB 15 KHATRI R IND
4 3 SALEEV E RUS P1 P2 4 2 2	7 1 EGY P1 P2 2 2 0	10 5 AZE P1 P2 3 3 0	
5 1 SHYSHMAN O UKR P1 P2 1 1 0	9 0 LTU P1 P2 0 0 0	15 1 ARM P1 P2 1 0 1	
6 1 KHOSRAVI M IRI P1 P2 2 2 0	10 3 AZE P1 P2 4 0 0	REPECHAGE	
7 3 MOHAMED T EGY P1 P2 2 2 0	13 1 KOR P1 P2 3 2 1	UPPER BRANCH	
8 0 MICHEL A LIB P1 P2 0 0 0	15 3 ARM P1 P2 8 0 8	LOWER BRANCH	
9 4 MATUZEVICIUS J LTU P1 P2 8 8 0	5 3 UKR P1 P2 6 0 6	5 3 UKR P1 P2 2 0 2	
10 3 HUSEYNOV R AZE P1 P2 8 2 6	7 1 EGY P1 P2 3 3 0	2 1 KAZ P1 P2 2 2 0	
11 1 TOOTS H EST P1 P2 2 0 2	11 0 EST P1 P2 4 4 0	5 SHYSHMAN O UKR	
12 0 EISELE P GER P1 P2 0 0 0	9 5 LTU P1 P2 2 2 0	9 0 LTU P1 P2 0 0 0	
13 5 KIM JH KOR P1 P2 0 0 0	15 3 ARM P1 P2 8 0 8	15 3 ARM P1 P2 2 2 1	
14 0 BUD OCHIR B MGL P1 P2 0 0 0	BRONZE	BRONZE	
15 4 KOCHARYAN S ARM P1 P2 8 8 0	BRONZE	15 KOCHARYAN S ARM	



Competition Sheet

체급별 대진 정보

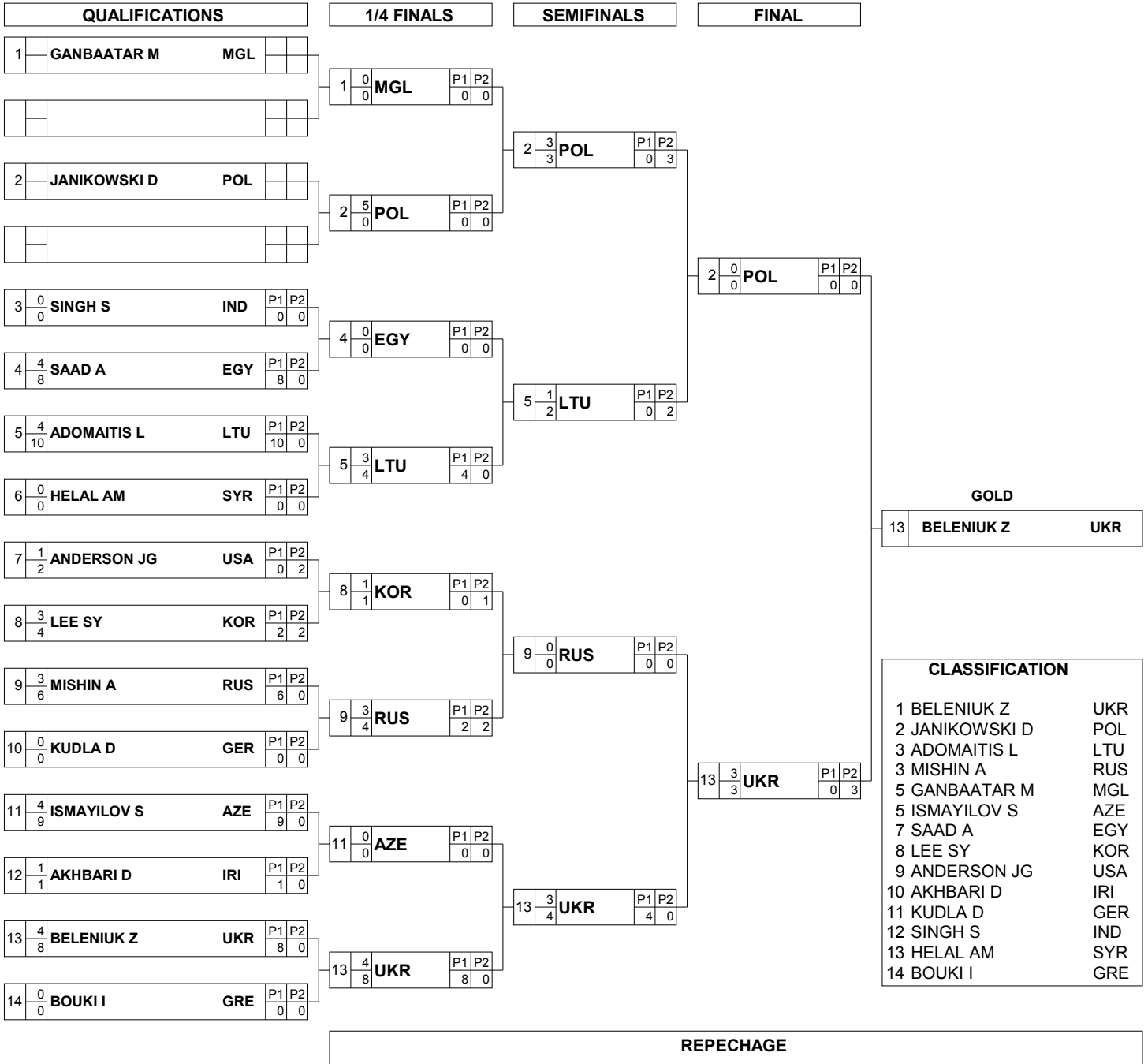

REPECHAGE

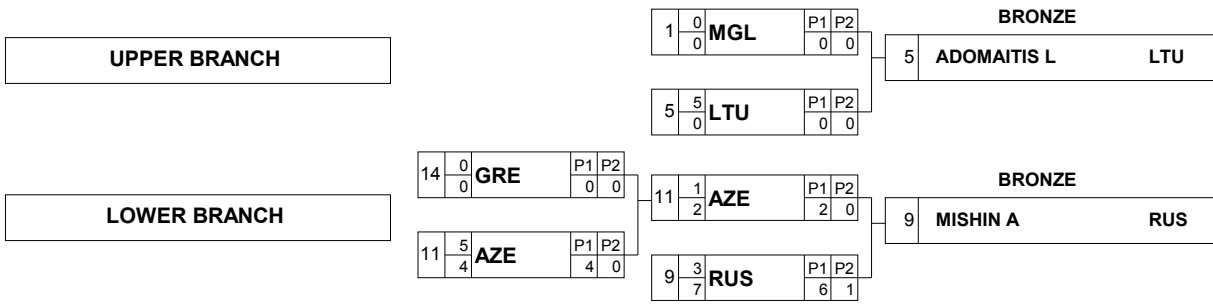



Competition Sheet

체급별 대진 정보

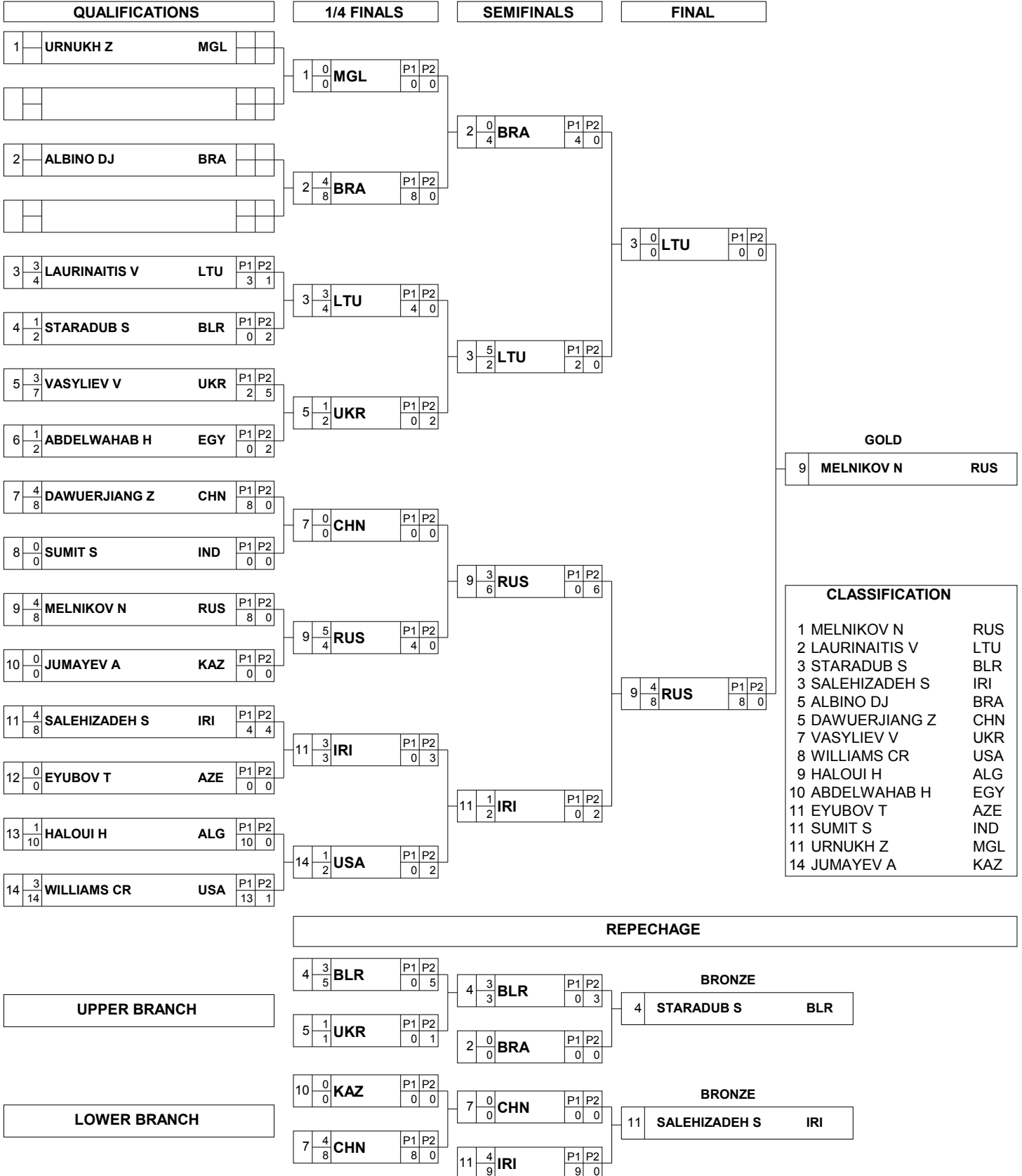



Competition Sheet

체급별 대진 정보

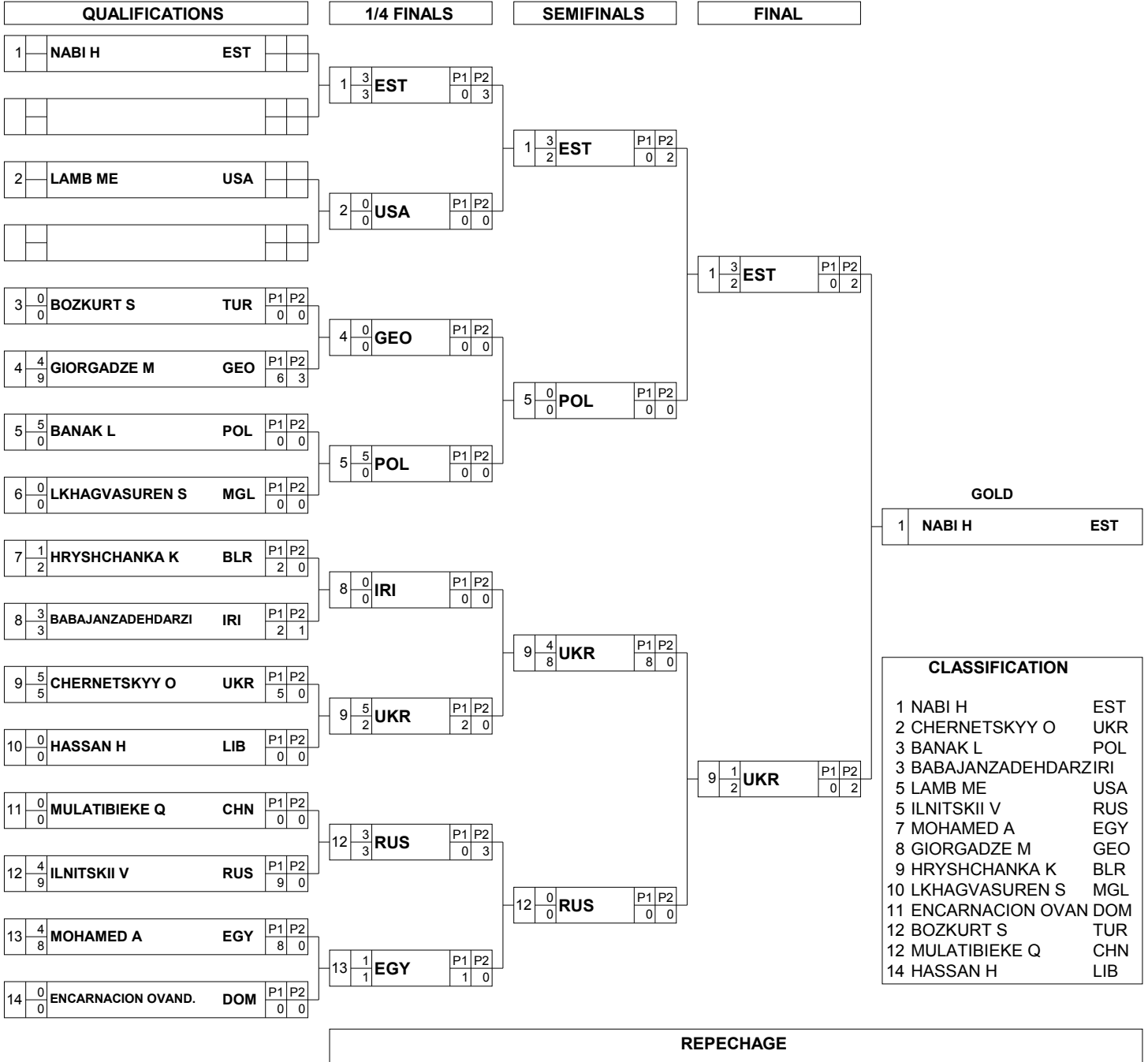

REPECHAGE

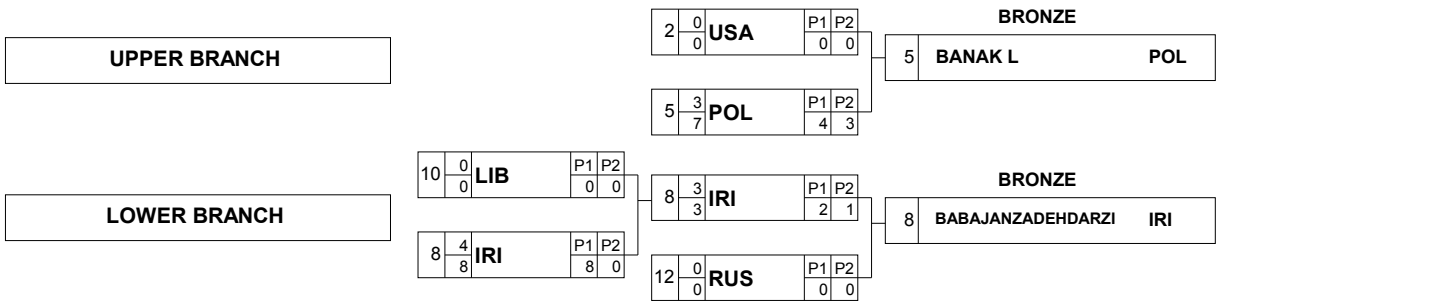



Competition Sheet

체급별 대진 정보

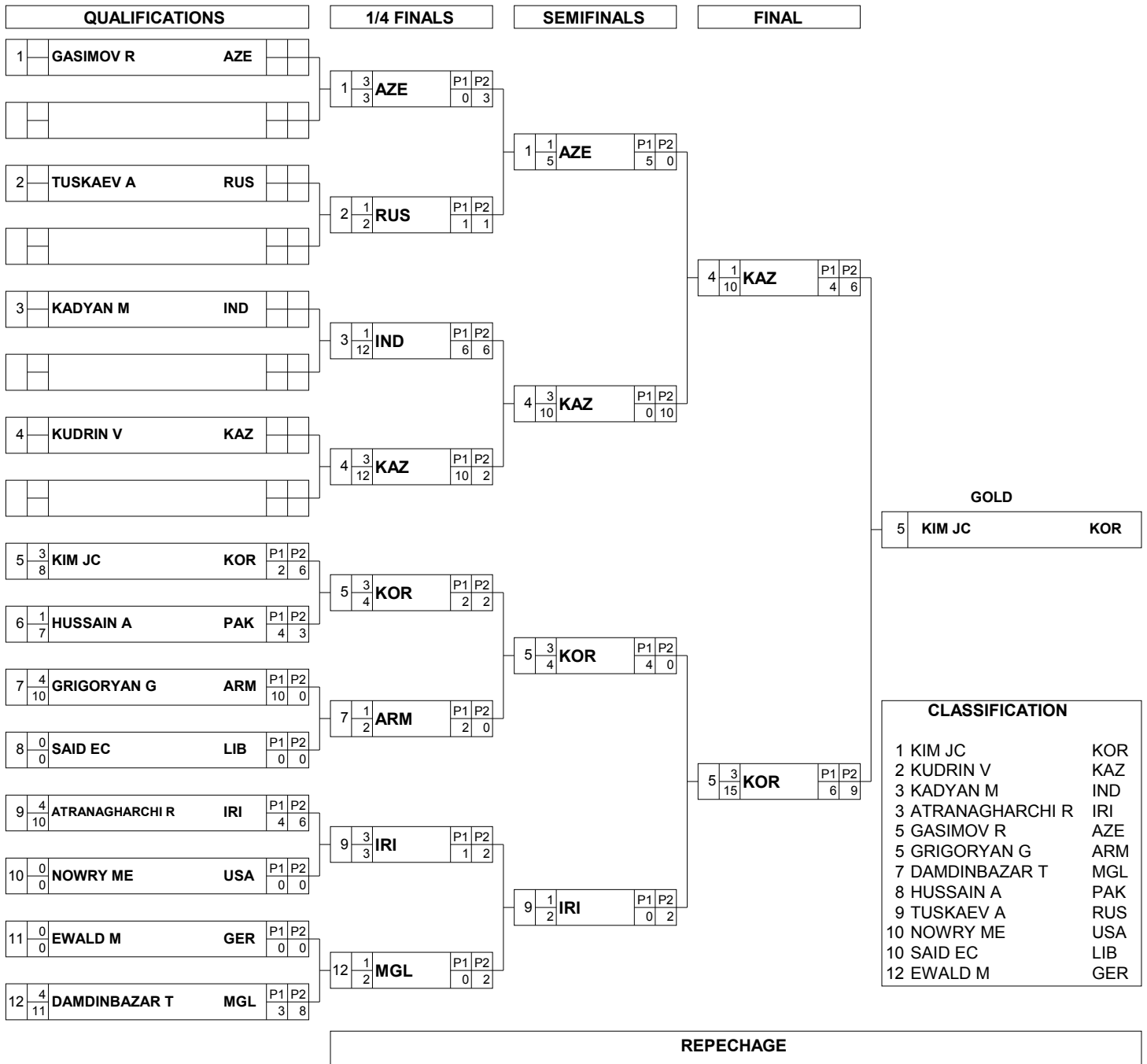

CLASSIFICATION		
1	KIM JC	KOR
2	KUDRIN V	KAZ
3	KADYAN M	IND
3	ATRANAGHARCHI R	IRI
5	GASIMOV R	AZE
5	GRIGORYAN G	ARM
7	DAMDINBAZAR T	MGL
8	HUSSAIN A	PAK
9	TUSKAEV A	RUS
10	NOWRY ME	USA
10	SAID EC	LIB
12	EWALD M	GER

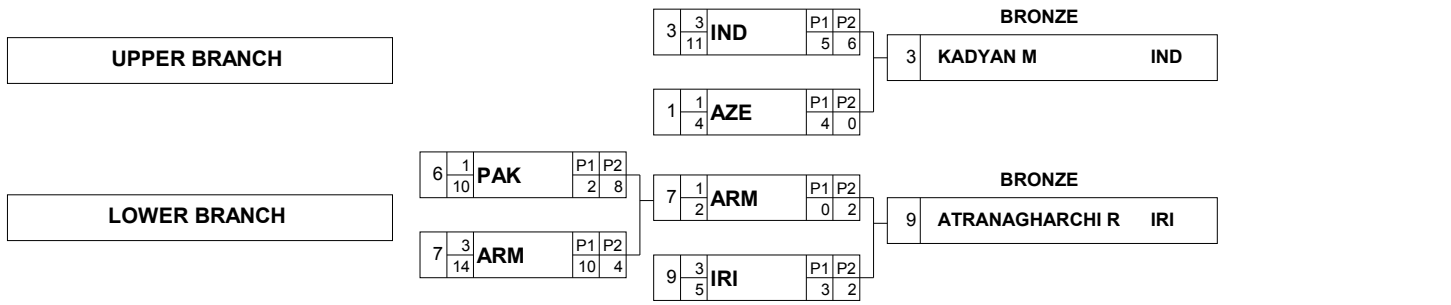



Competition Sheet
체급별 대진 정보

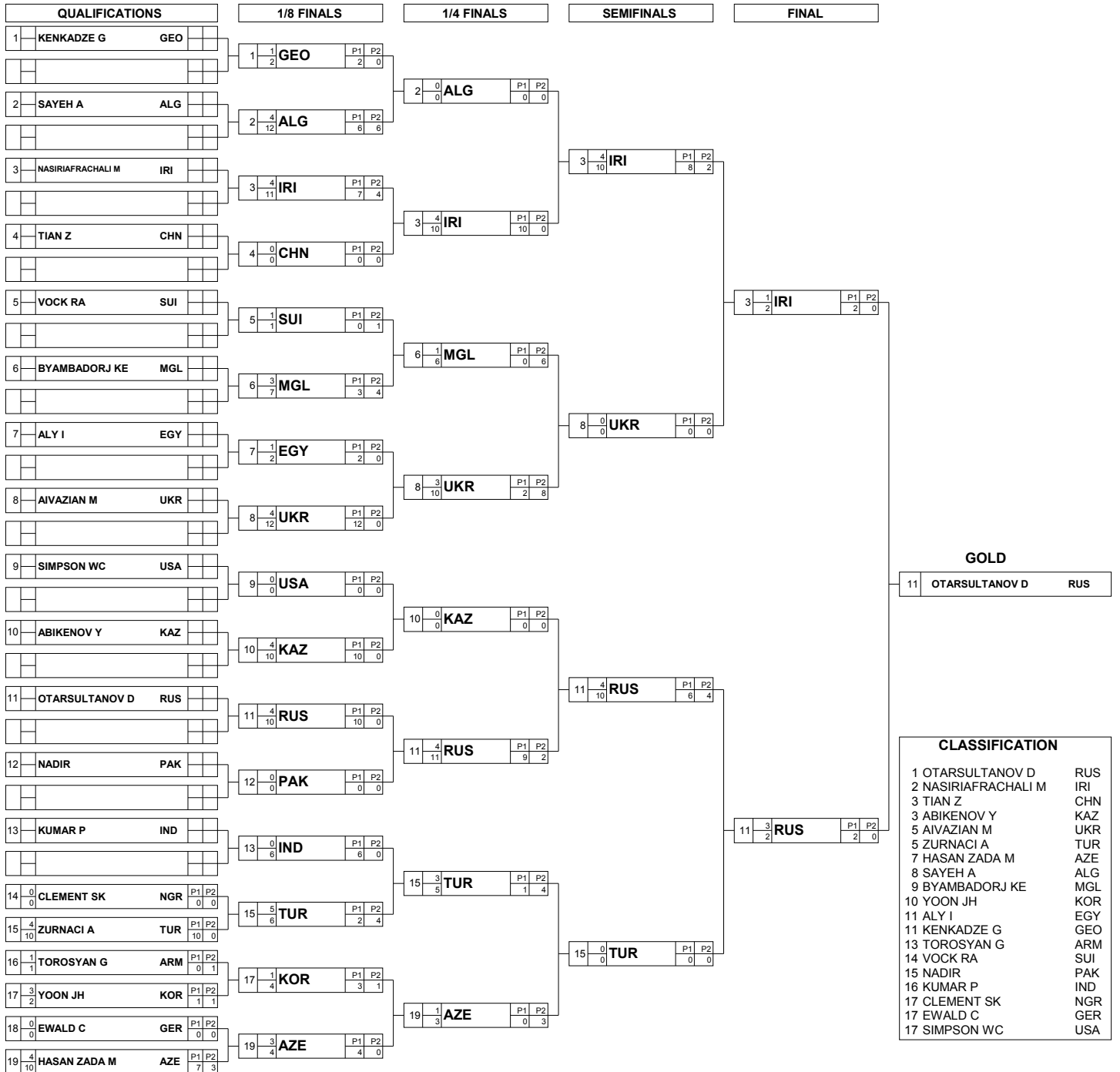

CLASSIFICATION

1	OTARSULTANOV D	RUS
2	NASIRIAFRACHALI M	IRI
3	TIAN Z	CHN
3	ABIKENOV Y	KAZ
5	AIVAZIAN M	UKR
5	ZURNACI A	TUR
7	HASAN ZADA M	AZE
8	SAYEH A	ALG
9	BYAMBADORJ KE	MGL
10	YOON JH	KOR
11	ALY I	EGY
11	KENKADZE G	GEO
13	TOROSYAN G	ARM
14	VOCK RA	SUI
15	NADIR	PAK
16	KUMAR P	IND
17	CLEMENT SK	NGR
17	EWALD C	GER
17	SIMPSON WC	USA

REPECHAGE

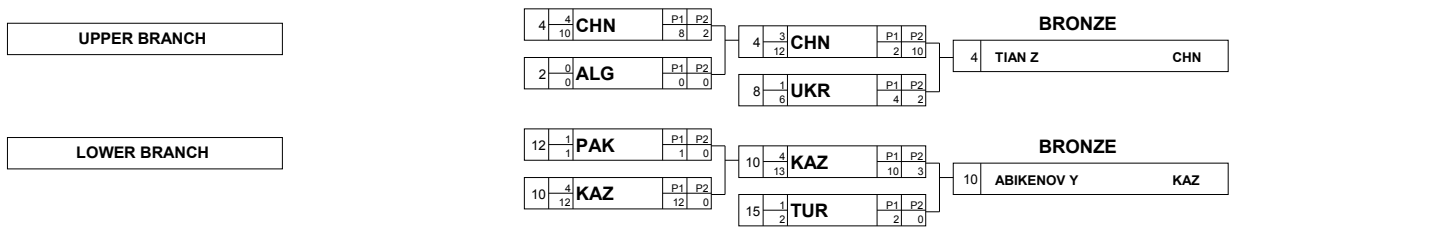



Competition Sheet

체급별 대진 정보



GOLD		
1	KVRBANALIEV M	RUS

CLASSIFICATION		
1	KVRBANALIEV M	RUS
2	HEYDARI M	IRI
3	MUSTAFAYEV A	AZE
4	SHAGAPULY A	KAZ
5	SHUPTAR V	UKR
6	BATCHULUUN B	MGL
7	AVETISYAN H	ARM
8	von OHLEN CL	USA
9	RAJNEESH R	IND
10	KIM JC	KOR
11	STATKIEWICZ R	POL
12	MOHAMED I	EGY
13	KIRAZ K	TUR
14	GEORGIEV I	MKD
15	HENKEL K	GER
16	JANELIDZE R	GEO

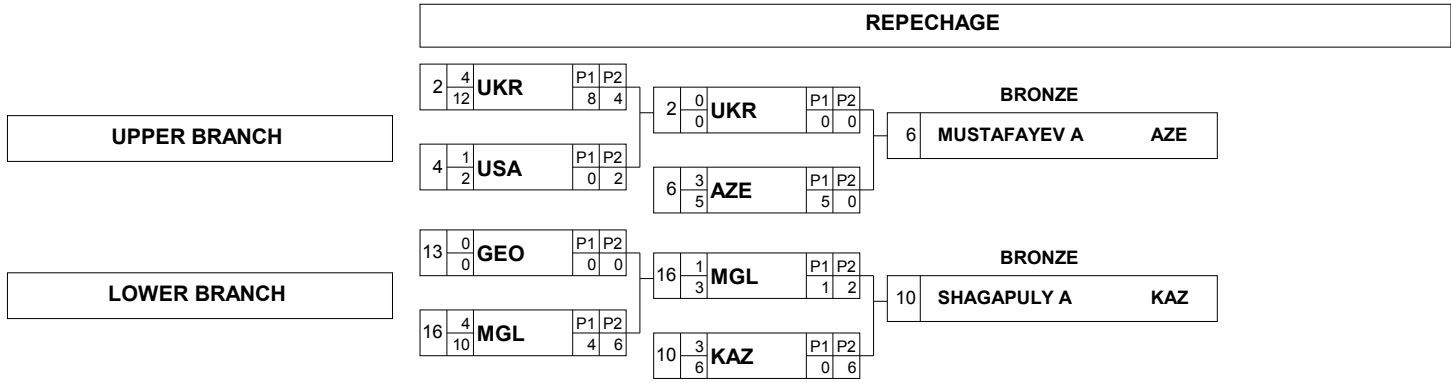



Competition Sheet

체급별 대진 정보

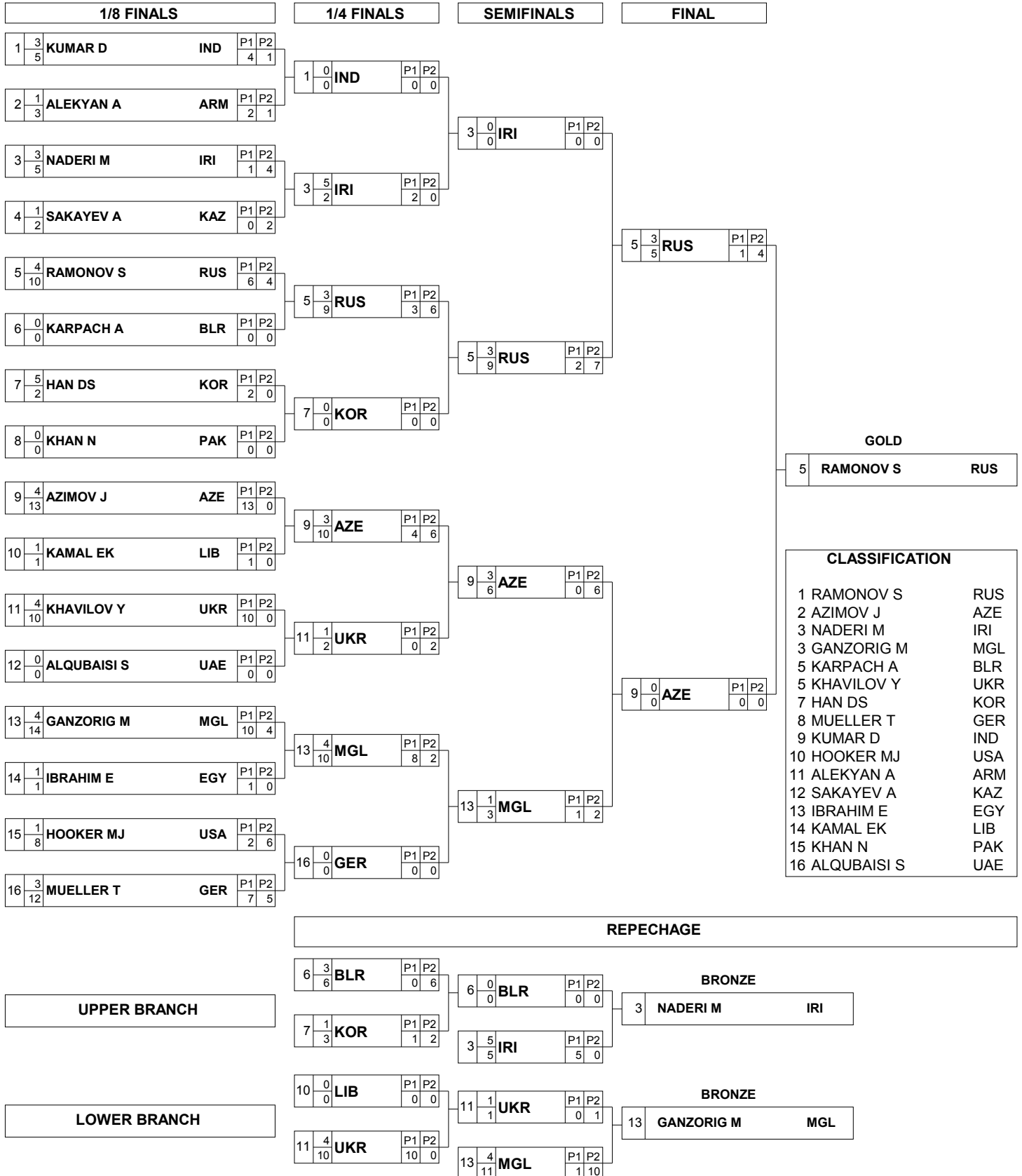



Competition Sheet

체급별 대진 정보



REPECHAGE

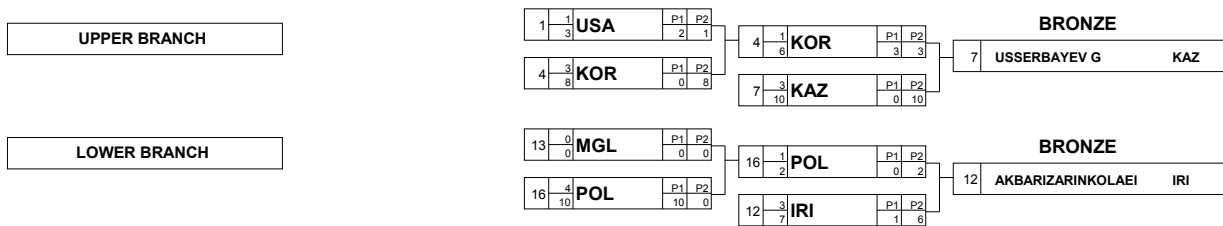



Competition Sheet

체급별 대진 정보

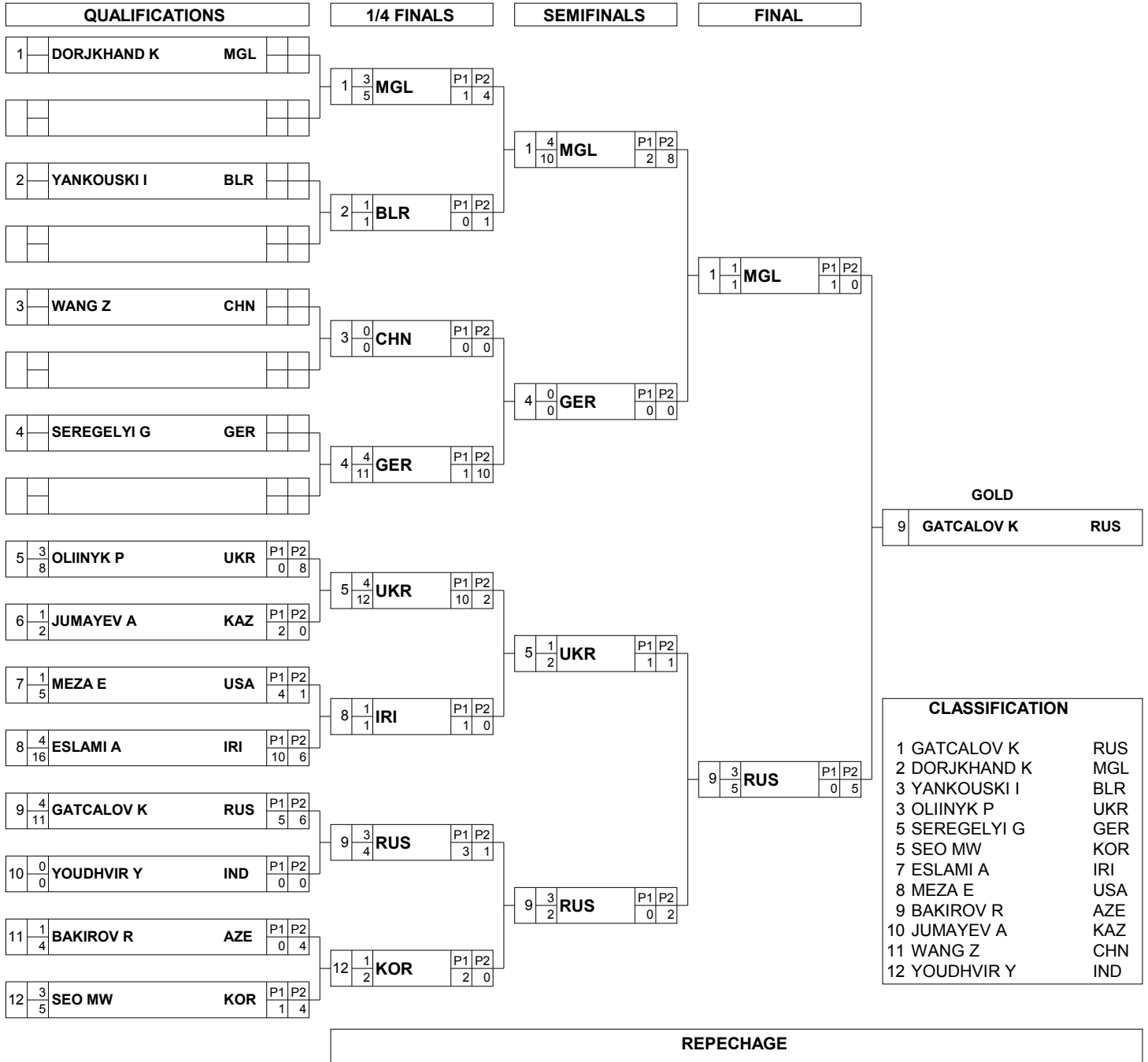



Competition Sheet

체급별 대진 정보

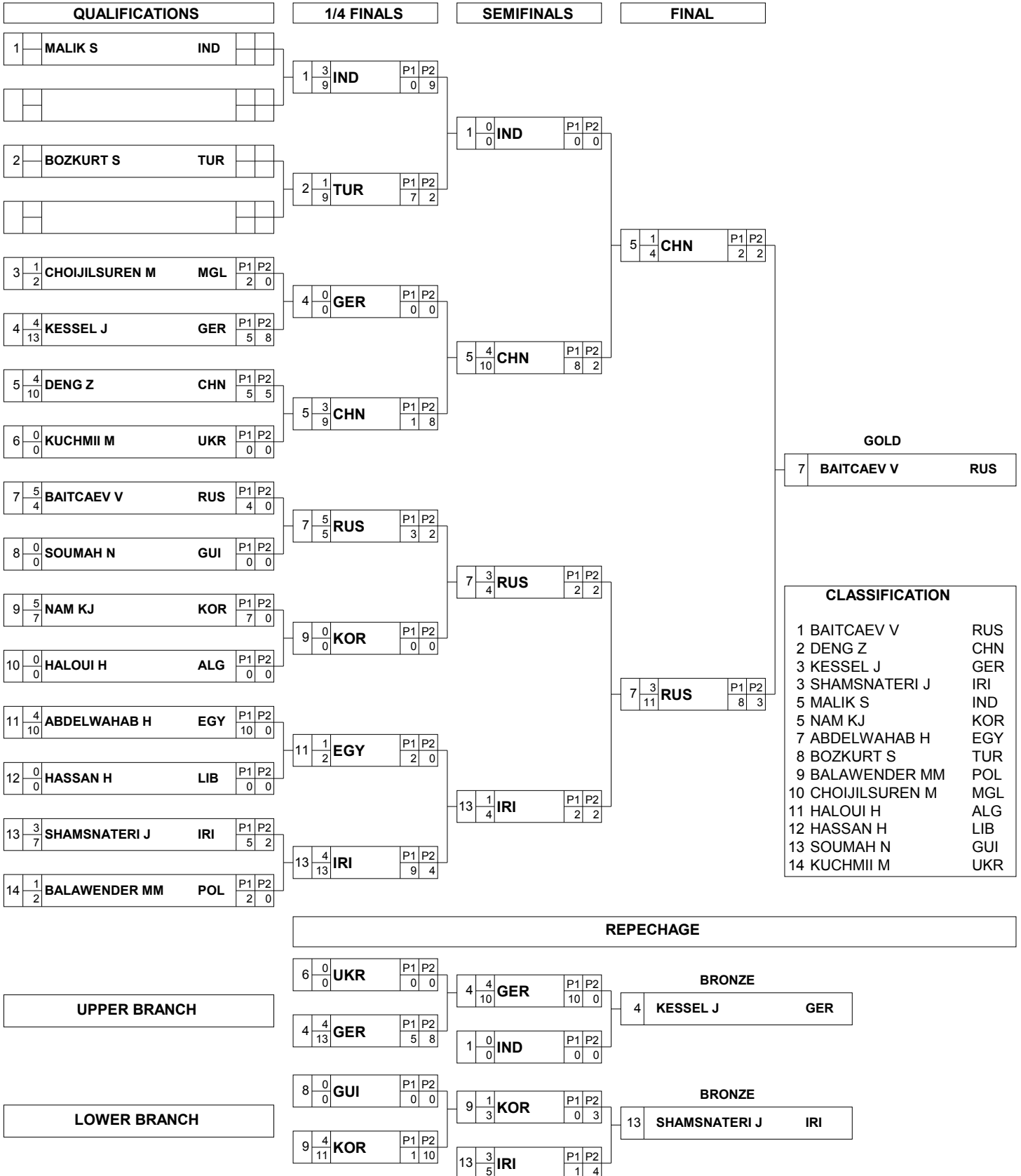



MUNGYEONG KOREA 2015
6th CISM World Games

Wrestling
레슬링
Men's Greco-Roman
남자 그레고로만형



Final Classification by Weight Category

체급별 최종 순위

As of SAT 10 OCT 2015

[Team Classification]

Rank	Nation	Points	Medal Counts
1	UKR-Ukraine	57	6
2	IRI-Iran	50	5
3	KOR-Korea, R.	44	4
4	EGY-Egypt	43	3
5	RUS-Russia	42	3
6	POL-Poland	30	2
7	LTU-Lithuania	29	2
8	KAZ-Kazakhstan	24	1
9	ARM-Armenia	23	2
10	USA-United States of America	22	1
11	AZE-Azerbaijan	17	1
12	EST-Estonia	12	1
13	BLR-Belarus	10	1
14	CHN-China	10	0
15	MGL-Mongolia	7	0
16	BRA-Brazil	6	0
16	FIN-Finland	6	0
16	TUR-Turkey	6	0
19	GER-Germany	4	0
20	GEO-Georgia	3	0
20	GRE-Greece	3	0
20	IND-India	3	0
23	ALG-Algeria	2	0
23	SUI-Switzerland	2	0
25	SVK-Slovakia	1	0
26	DOM-Dominican Republic	0	0
26	LIB-Lebanon	0	0
26	NGR-Nigeria	0	0
26	PAK-Pakistan	0	0
26	SYR-Syrian Arab Republic	0	0
26	TUN-Tunisia	0	0



MUNGYEONG KOREA 2015
6th CISM World Games

Wrestling
레슬링
Men's Greco-Roman
남자 그레고로만형



Final Classification by Weight Category

체급별 최종 순위

As of SAT 10 OCT 2015

Rank	Name	CDM Code	Rank	Name	CDM Code
59kg			71kg		
Gold	AINAGULOV Mirambek	KAZ	Gold	GERAYEE Mohammadali	IRI
Silver	MAHMOUD Haitham	EGY	Silver	LEE Jeong Geun	KOR
Bronze	CHOI Hyeong Muk	KOR	Bronze	SAVCHENKO Mykola	UKR
Bronze	HAJIPOUR Mohsen	IRI	Bronze	ELDSOUKY Ibrahim	EGY
5	KIRAZ Kursat	TUR	5	HALMESMAEKI Tero	FIN
5	KUYLAKOV Ivan	RUS	5	ALEKSANYAN Rafayel	ARM
7	SCHMITT Fabian	GER	7	BAYAKHMETOV Darkhan	KAZ
8	TRACZ Michal Jacek	POL	8	KRACZKOWSKI Przemyslaw	POL
9	MIAGKYI Ievgen	UKR	9	KIIANKIN Aleksei	RUS
10	MAMMADOV Ramiz	AZE	10	JAKUS Vojtech	SVK
11	YAN de	CHN	11	YADAV Kk	IND
12	SINGH Sukhvir	IND	12	BOUDJEMLINE Akrem	ALG
13	GHARIBYAN Gevorg	ARM	13	HOOKER Michael Joseph	USA
14	KALIL Aaron David	USA	14	KAMAL EI Khatib	LIB
14	RIBEIRO ROMANELLI Diego	BRA	14	NASIBOV Samran	AZE
16	SAID EI Chami	LIB	16	OZDEMIR Ahmet	TUR
66kg			75kg		
Gold	KIM Ji Hun	KOR	Gold	KIM Jin Hyeok	KOR
Silver	ASLANYAN Karen	ARM	Silver	LESTER Justin Dashaun	USA
Bronze	NOROOZI Omid	IRI	Bronze	PYSHKOV Dmytro	UKR
Bronze	DEMYANKOV Denys	UKR	Bronze	GHANEM Ibrahim	EGY
5	SLEIVA Kristupas	LTU	5	HEDAYAT Behrooz	IRI
5	MOHAMED Hussein	EGY	5	KLIMEK Dawid Piotr	POL
7	ZHAKANSHA Bagylan	KAZ	7	QING Gele	CHN
8	YADAV Suresh Kumar	IND	8	PREVOLARAKIS Georgios	GRE
9	JOHNSON Jamel Rasheed	USA	9	DIETSCHKE Damian	SUI
10	KARECINSKI Dawid	POL	10	ISAKOV Ruslan	RUS
11	ALBIEV Islam Beka	RUS	11	MARQUES MOREIRA Angelo Rafael	BRA
12	KASSAB Saleh	SYR	12	SONU Sonu	IND
13	BENAISSA Tarek Aziz	ALG	13	ALHAYEK Abdullah	SYR
14	NADIR	PAK	13	BILEL Wechtati	TUN
14	ZURNACI Abdi	TUR	13	KHAN Nadir	PAK
16	MENEKSE Deniz	GER	16	OKEKE Tochukwu Micheal	NGR
			17	IBRAHIMLI Javid	AZE



MUNGYEONG KOREA 2015
6th CISM World Games

Wrestling
레슬링
Men's Greco-Roman
남자 그레고로만형



Final Classification by Weight Category

체급별 최종 순위

As of SAT 10 OCT 2015

Rank	Name	CDM Code	Rank	Name	CDM Code
80kg			98kg		
Gold	HUSEYNOV Rafiq	AZE	Gold	MELNIKOV Nikita	RUS
Silver	SALEEV Evgeny	RUS	Silver	LAURINAITIS Vilius	LTU
Bronze	SHYSHMAN Oleksandr	UKR	Bronze	STARADUB Siarhei	BLR
Bronze	KOCHARYAN Sargis	ARM	Bronze	SALEHIZADEH Seyedmostafa	IRI
5	DILMUKHAMEDOV Askhat	KAZ	5	ALBINO Davi Jose	BRA
5	MATUZEVICIUS Julius	LTU	5	DAWUERJIANG Zikela	CHN
7	KIM June Hyoung	KOR	7	VASYLIEV Volodymyr	UKR
8	MOHAMED Tarek	EGY	8	WILLIAMS Caylor Ryan	USA
9	TOOTS Hardo	EST	9	HALOUI Hemza	ALG
10	KHOSRAVI Milad	IRI	10	ABDELWAHAB Hamdy	EGY
11	YAO Xiaobin	CHN	11	EYUBOV Turman	AZE
12	EISELE Pascal	GER	11	SUMIT Sumit	IND
13	BUD OCHIR Boldbaatar	MGL	11	URNUKH Zolbayar	MGL
13	MICHEL Alsoury	LIB	14	JUMAYEV Alikhan	KAZ
15	KHATRI Ravinder	IND			
85kg			130kg		
Gold	BELENIUK Zhan	UKR	Gold	NABI Heiki	EST
Silver	JANIKOWSKI Damian	POL	Silver	CHERNETSKYY Oleksandr	UKR
Bronze	ADOMAITIS Laimutis	LTU	Bronze	BANAK Lukasz	POL
Bronze	MISHIN Aleksei	RUS	Bronze	BABAJANZADEHDARZI Bashir	IRI
5	GANBAATAR Mendbayar	MGL	5	LAMB Matthew Everette	USA
5	ISMAYILOV Sultan	AZE	5	ILNITSKII Vitalii	RUS
7	SAAD Ahmed	EGY	7	MOHAMED Abdellatif	EGY
8	LEE Se Yeol	KOR	8	GIORGADZE Mirian	GEO
9	ANDERSON Jonathan Gregory	USA	9	HRYSHCHANKA Kiryl	BLR
10	AKHBARI Davood	IRI	10	LKHAGVASUREN Shinebaatar	MGL
11	KUDLA Denis	GER	11	ENCARNACION OVANDO Josue Malaquia	DOM
12	SINGH Surrender	IND	12	BOZKURT Sakir	TUR
13	HELAL Abdi Malek	SYR	12	MULATIBIEKE Qiayisuoletan	CHN
14	BOUKI Ilias	GRE	14	HASSAN Hamieh	LIB



MUNGYEONG KOREA 2015
6th CISM World Games

Wrestling
레슬링
Men's Freestyle
남자 자유형



Final Classification by Weight Category

체급별 최종 순위

As of WED 7 OCT 2015

[Team Classification]

Rank	Nation	Points	Medal Counts
1	RUS-Russia	72	7
2	IRI-Iran	63	7
3	KAZ-Kazakhstan	42	5
4	MGL-Mongolia	38	3
5	KOR-Korea, R.	34	1
6	GER-Germany	32	2
7	AZE-Azerbaijan	29	2
8	UKR-Ukraine	26	1
9	IND-India	21	1
10	BLR-Belarus	20	1
11	CHN-China	18	2
12	USA-United States of America	14	0
13	ARM-Armenia	10	0
14	TUR-Turkey	9	0
15	POL-Poland	8	0
16	EGY-Egypt	5	0
17	TUN-Tunisia	4	0
18	ALG-Algeria	3	0
18	GRE-Greece	3	0
18	PAK-Pakistan	3	0
21	LAT-Latvia	2	0
22	LIB-Lebanon	1	0
23	BRA-Brazil	0	0
23	GEO-Georgia	0	0
23	GUI-Guinea	0	0
23	MKD-FYROM	0	0
23	NGR-Nigeria	0	0
23	SUI-Switzerland	0	0
23	SYR-Syrian Arab Republic	0	0
23	UAE-United Arab Emirates	0	0



MUNGYEONG KOREA 2015
6th CISM World Games

Wrestling
레슬링
Men's Freestyle
남자 자유형



Final Classification by Weight Category

체급별 최종 순위

As of WED 7 OCT 2015

Rank	Name	CDM Code	Rank	Name	CDM Code
57kg			65kg		
Gold	KIM Jin Cheol	KOR	Gold	KVRBANALIEV Magomed	RUS
Silver	KUDRIN Vladimir	KAZ	Silver	HEYDARI Meisam	IRI
Bronze	KADYAN Mangal	IND	Bronze	MUSTAFAYEV Aghahuseyn	AZE
Bronze	ATRANAGHARCHI Reza	IRI	Bronze	SHAGAPULY Azamat	KAZ
5	GASIMOV Ruslan	AZE	5	SHUPTAR Vasyil	UKR
5	GRIGORYAN Gor	ARM	5	BATCHULUUN Batmagnai	MGL
7	DAMDINBAZAR Tsogtbaatar	MGL	7	AVETISYAN Hakob	ARM
8	HUSSAIN Azhar	PAK	8	von OHLEN Cole Landon	USA
9	TUSKAEV Azamat	RUS	9	RAJNEESH Rajneesh	IND
10	NOWRY Max Emiliano	USA	10	KIM Jun Chul	KOR
10	SAID EI Chami	LIB	11	STATKIEWICZ Rafal	POL
12	EWALD Marcel	GER	12	MOHAMED Ibrahim	EGY
			13	KIRAZ Kursat	TUR
			14	GEORGIEV Ile	MKD
			15	HENKEL Kevin	GER
			16	JANELIDZE Revazi	GEO
61kg			70kg		
Gold	OTARSULTANOV Dzhamal	RUS	Gold	RAMONOV Soslan	RUS
Silver	NASIRIAFRACHALI Mehran	IRI	Silver	AZIMOV Joshgun	AZE
Bronze	TIAN Zhenguang	CHN	Bronze	NADERI Mohammad	IRI
Bronze	ABIKENOV Yeldos	KAZ	Bronze	GANZORIG Mandakhnaran	MGL
5	AIVAZIAN Mykola	UKR	5	KARPACH Andrei	BLR
5	ZURNACI Abdi	TUR	5	KHAVILOV Yevhenii	UKR
7	HASAN ZADA Mirjalal	AZE	7	HAN Dae Su	KOR
8	SAYEH Abderrahim	ALG	8	MUELLER Tim	GER
9	BYAMBADORJ Khash Erdene	MGL	9	KUMAR Dinesh	IND
10	YOON Ji Hun	KOR	10	HOOKER Michael Joseph	USA
11	ALY Ibrahim	EGY	11	ALEKYAN Aren	ARM
11	KENKADZE Giorgi	GEO	12	SAKAYEV Azat	KAZ
13	TOROSYAN Gor	ARM	13	IBRAHIM Eyad	EGY
14	VOCK Randy Adrian	SUI	14	KAMAL EI Khatib	LIB
15	NADIR	PAK	15	KHAN Nadir	PAK
16	KUMAR Pradeep	IND	16	ALQUBAISI Saeed	UAE
17	CLEMENT Solikume Koffi	NGR			
17	EWALD Christoph	GER			
17	SIMPSON William Christopher	USA			



MUNGYEONG KOREA 2015
6th CISM World Games

Wrestling
레슬링
Men's Freestyle
남자 자유형



Final Classification by Weight Category

체급별 최종 순위

As of WED 7 OCT 2015

Rank	Name	CDM Code	Rank	Name	CDM Code
74kg			97kg		
Gold	TCABOLOV Khetik	RUS	Gold	GATCALOV Khadzhimurot	RUS
Silver	HARTH Georg	GER	Silver	DORJKHAND Khuderbulga	MGL
Bronze	USSERBAYEV Galymzhan	KAZ	Bronze	YANKOUSKI Ivan	BLR
Bronze	AKBARIZARINKOLAEI Ezzatollah	IRI	Bronze	OLIINYK Pavlo	UKR
5	LEE Yun Seok	KOR	5	SEREGELYI Gabriel	GER
5	BRZOZOWSKI Krystian	POL	5	SEO Min Won	KOR
7	BILEL Wechtati	TUN	7	ESLAMI Abazar	IRI
8	PREVOLARAKIS Georgios	GRE	8	MEZA Endhyr	USA
9	DOMBROVSKYY Valdyslav	USA	9	BAKIROV Roman	AZE
10	AHMED Abdou	EGY	10	JUMAYEV Alikhan	KAZ
11	PARDEEP Pardeep	IND	11	WANG Zhengtao	CHN
12	LI Quan	CHN	12	YOUHDVIR Youdhvir	IND
13	ZAKHAREVYCH Oleg	UKR			
14	ALQUBAISI Mohamed	UAE			
15	BARRY Oumar Issa	GUI			
16	OZDEMIR Ahmet	TUR			
17	BAT ERDENE Byambadorj	MGL			
86kg			125kg		
Gold	KUDIAMAGOMEDOV Shamil	RUS	Gold	BAITCAEV Vladislav	RUS
Silver	EBRAHIMIZIVLAEI Mohammadjavad	IRI	Silver	DENG Zhiwei	CHN
Bronze	ORGODOL Uitumen	MGL	Bronze	KESSEL Johannes	GER
Bronze	DAVLUMBAYEV Adilet	KAZ	Bronze	SHAMSNATERI Jafar	IRI
5	HARTH William	GER	5	MALIK Satender	IND
5	HUSHTYN Aliaksandr	BLR	5	NAM Kyung Jin	KOR
7	TERRELL II Victor Wesley	USA	7	ABDELWAHAB Hamdy	EGY
8	NAIN Karamjeet	IND	8	BOZKURT Sakir	TUR
9	OZOLINS OZOLS Andris	LAT	9	BALAWENDER Maciej Michal	POL
10	HUWATIBIEKE Bahetihan	CHN	10	CHOIJILSUREN Munkhtogtokh	MGL
11	KIM Gwan Uk	KOR	11	HALOUI Hemza	ALG
12	RIESEN Marco Lukas	SUI	12	HASSAN Hamieh	LIB
13	YUSUBOV Ibrahim	AZE	13	SOUMAH Nfamoussa	GUI
14	MOHAMED Mohamed	EGY	14	KUCHMII Mykola	UKR
15	ABOU JAOUDE Adrian Antoine	BRA			
16	MICHEL Alsoury	LIB			
17	BILOTSEKIVSKYI Oleh	UKR			
18	GHAILANI Jasem	UAE			
19	HELAL Abdl Malek	SYR			