

# 2014 Bill Farrell International Open

GR 59 KG

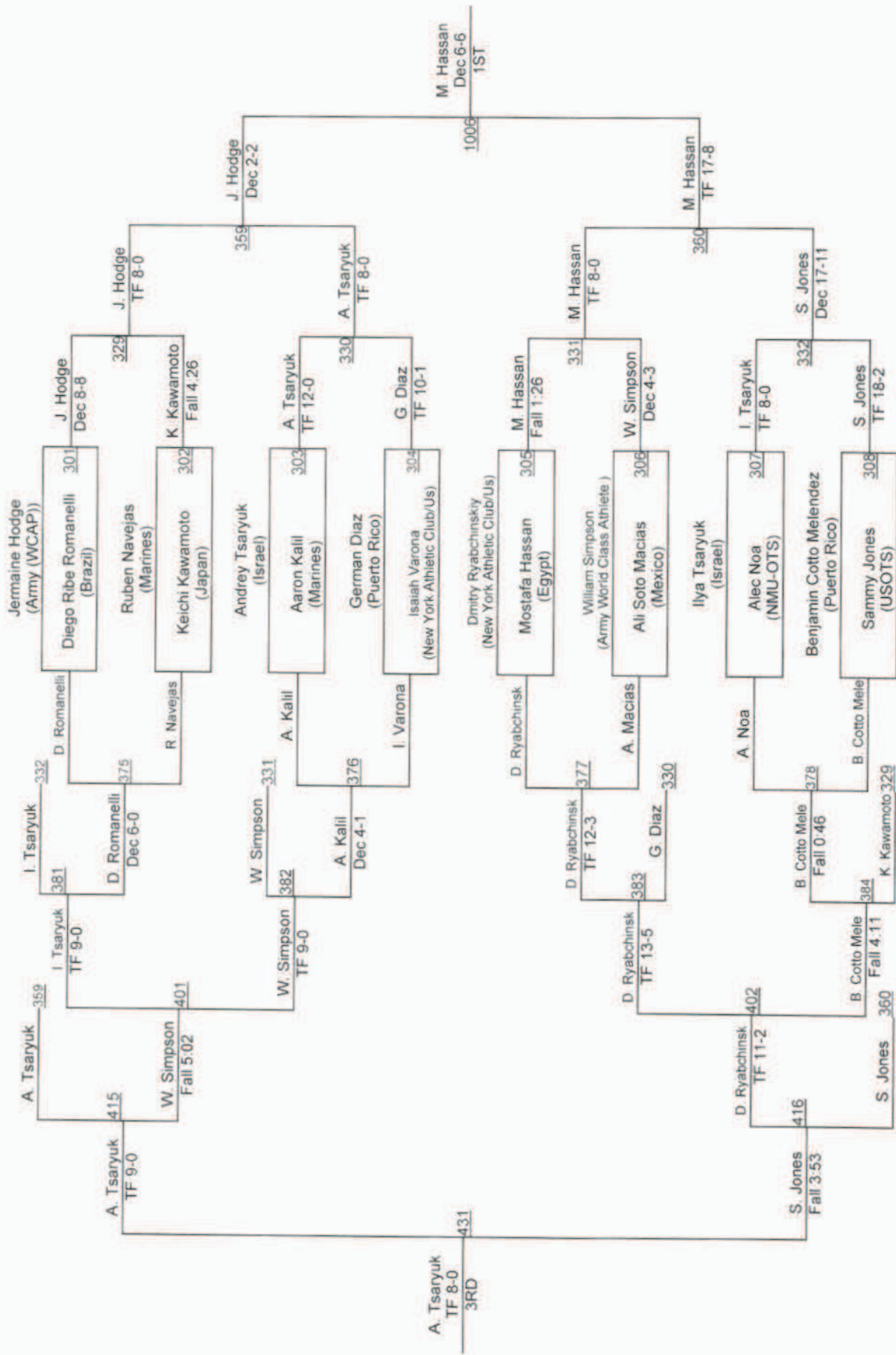



# 2014 Bill Farrell International Open

GR 71 KG

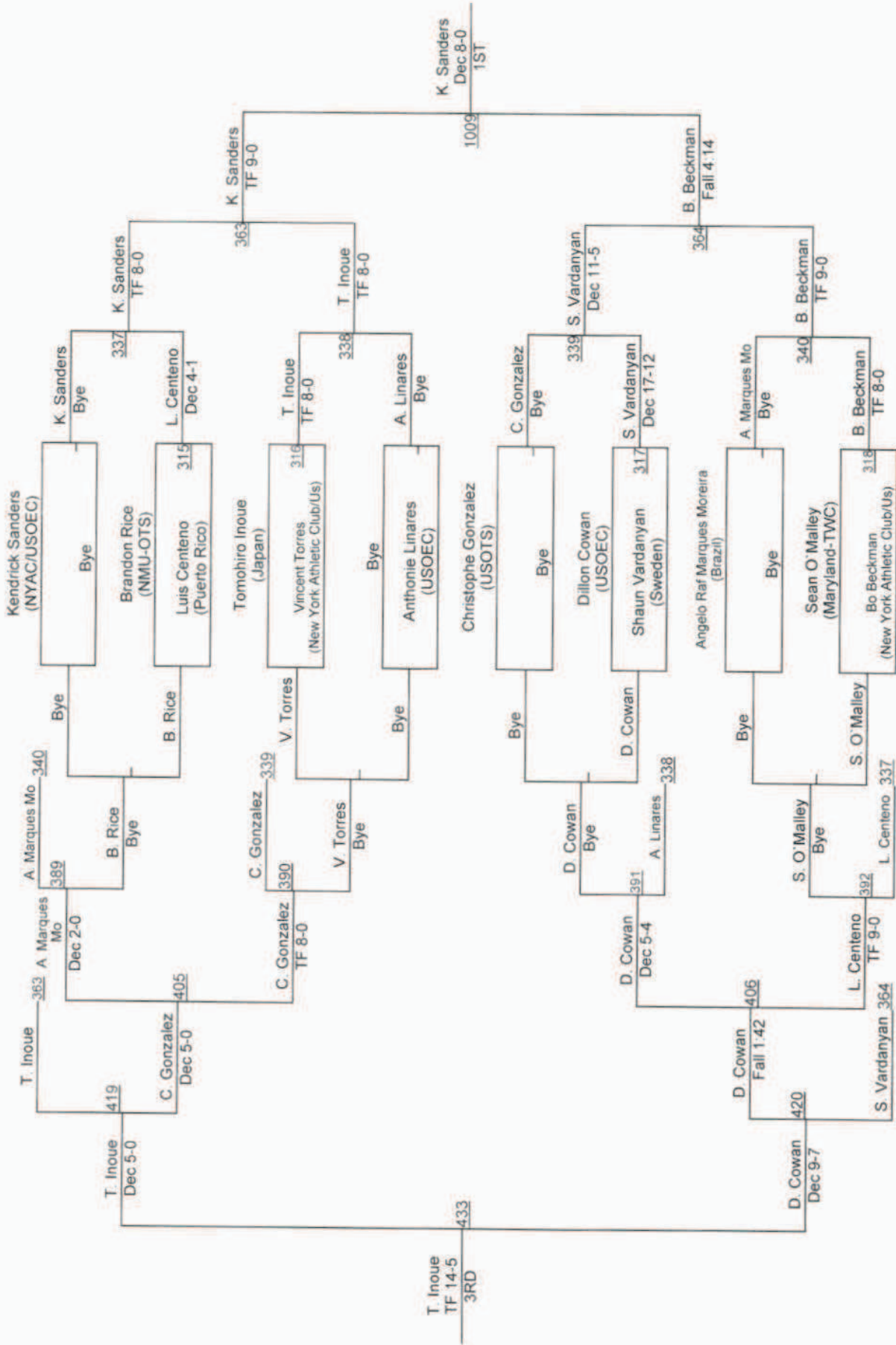

# 2014 Bill Farrell International Open

## GR 75 KG

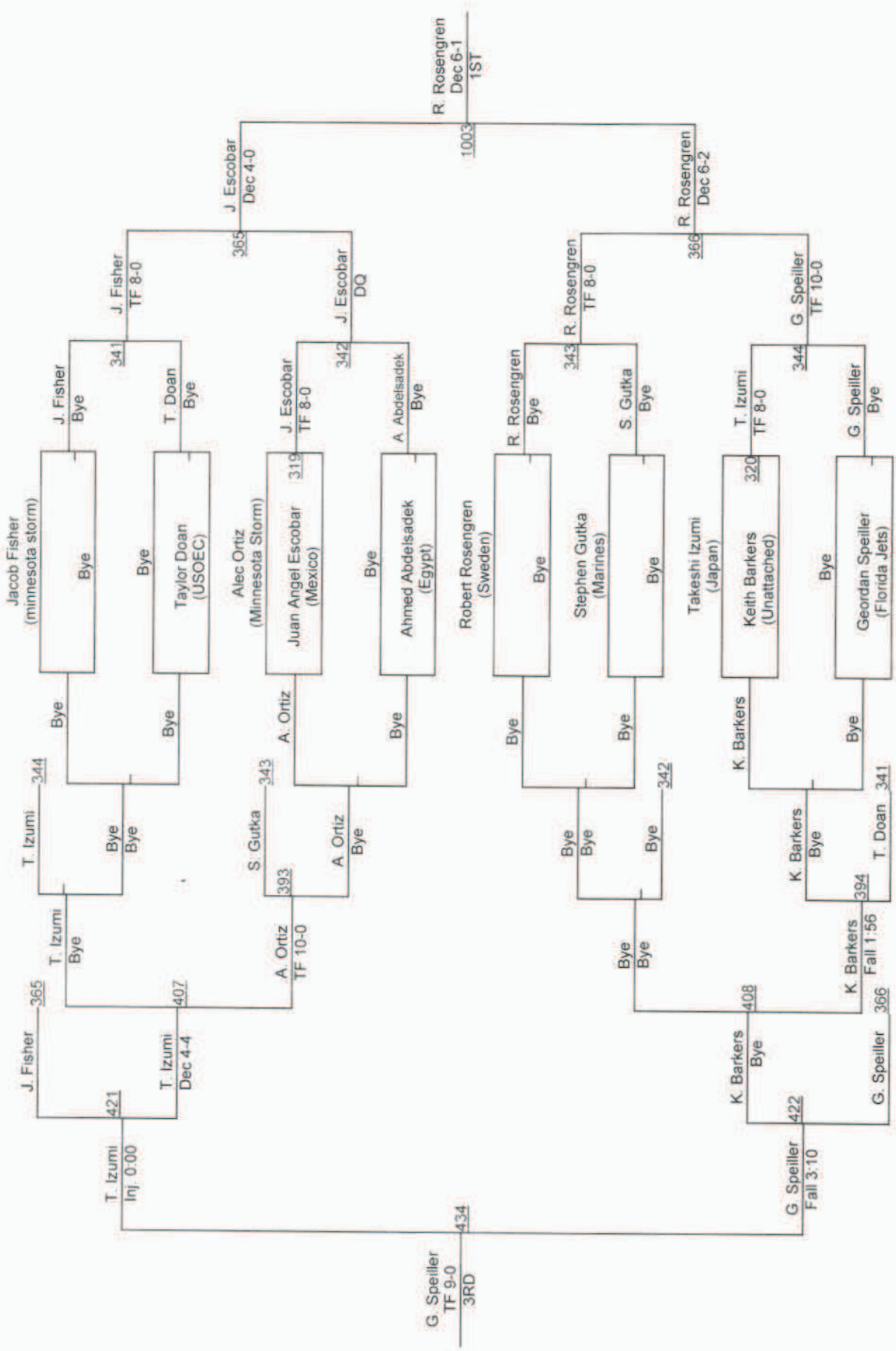

# 2014 Bill Farrell International Open

## GR 80 KG

### Round 1

Josh Greer United States	Cheney Haight United States
321	TF 8-0

Patrick Martinez United States	Ben Provisor United States
322	Dec 3-0

B. Provisor (New York Athletic Club/Us)  
1ST

### Round 2

Takayuki Murakami Japan	Josh Greer United States
345	Dec 4-0

Cheney Haight United States	Patrick Martinez United States
346	Dec 6-4

P. Martinez (Florida Jets)  
2ND

### Round 3

Ben Provisor United States	Josh Greer United States
367	Inj. 0:00

Takayuki Murakami Japan	Cheney Haight United States
368	TF 9-0

C. Haight (New York Athletic Club/Us)  
3RD

### Round 4

Patrick Martinez United States	Josh Greer United States
423	Inj. 0:00

Ben Provisor United States	Takayuki Murakami Japan
424	TF 10-1

T. Murakami (Japan)  
4TH

### Round 5

Cheney Haight United States	Ben Provisor United States
2004	TF 9-1

Patrick Martinez United States	Takayuki Murakami Japan
1005	Fall 1:01

J. Greer (NMU-OTS)  
5TH

# 2014 Bill Farrell International Open

## GR 85 KG

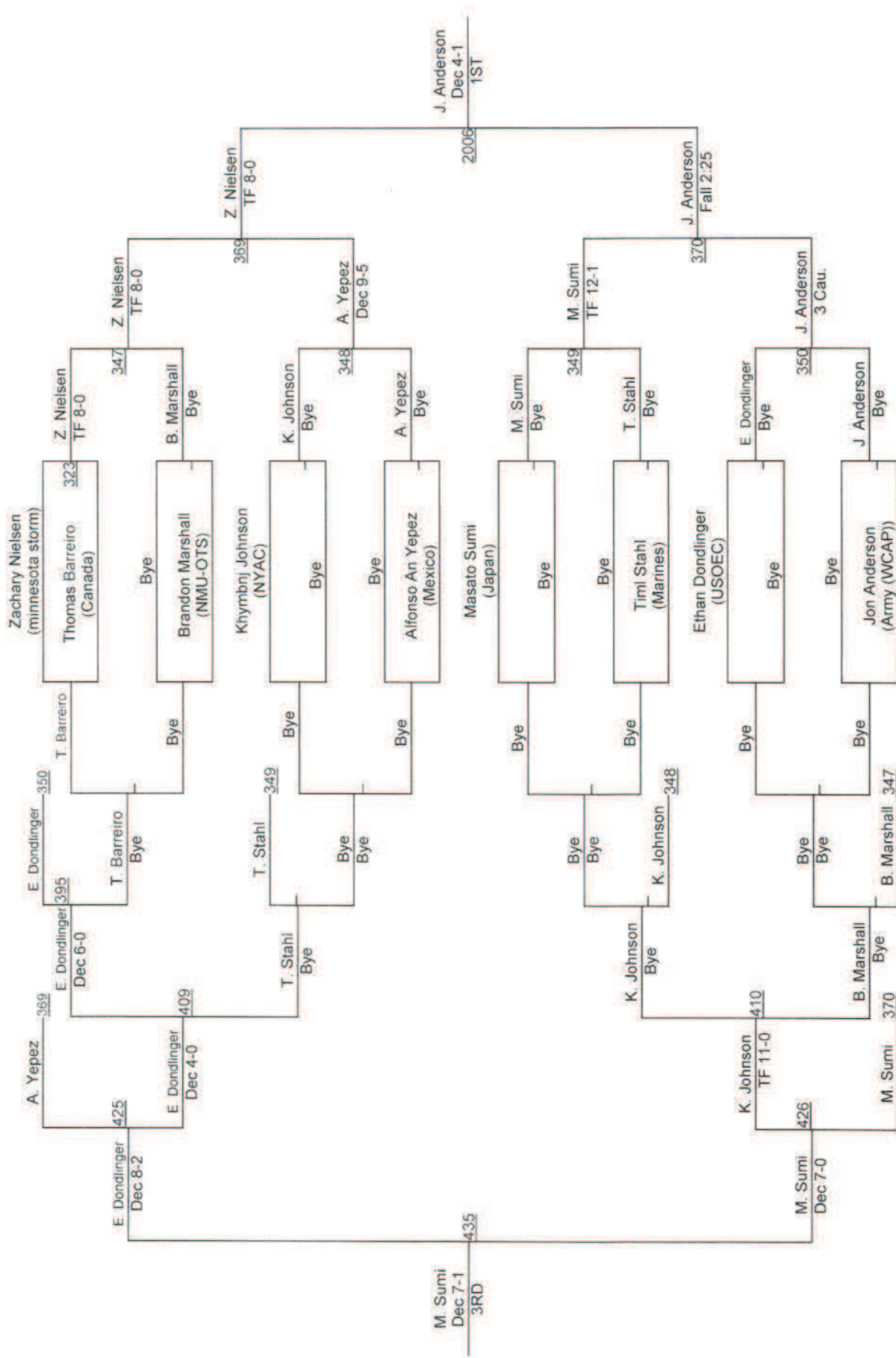

# 2014 Bill Farrell International Open

## GR 98 KG

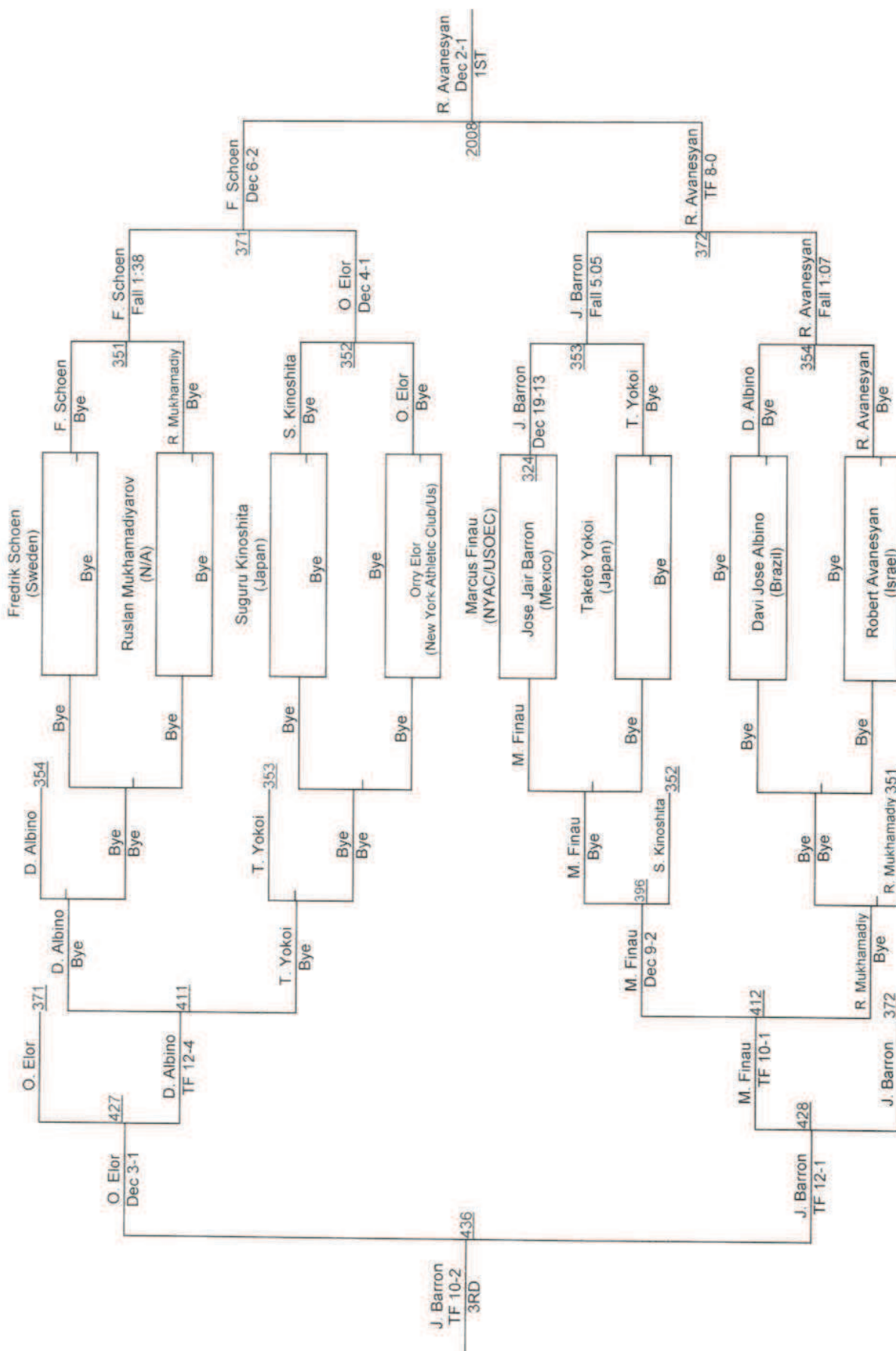

# 2014 Bill Farrell International Open

## GR 130 KG

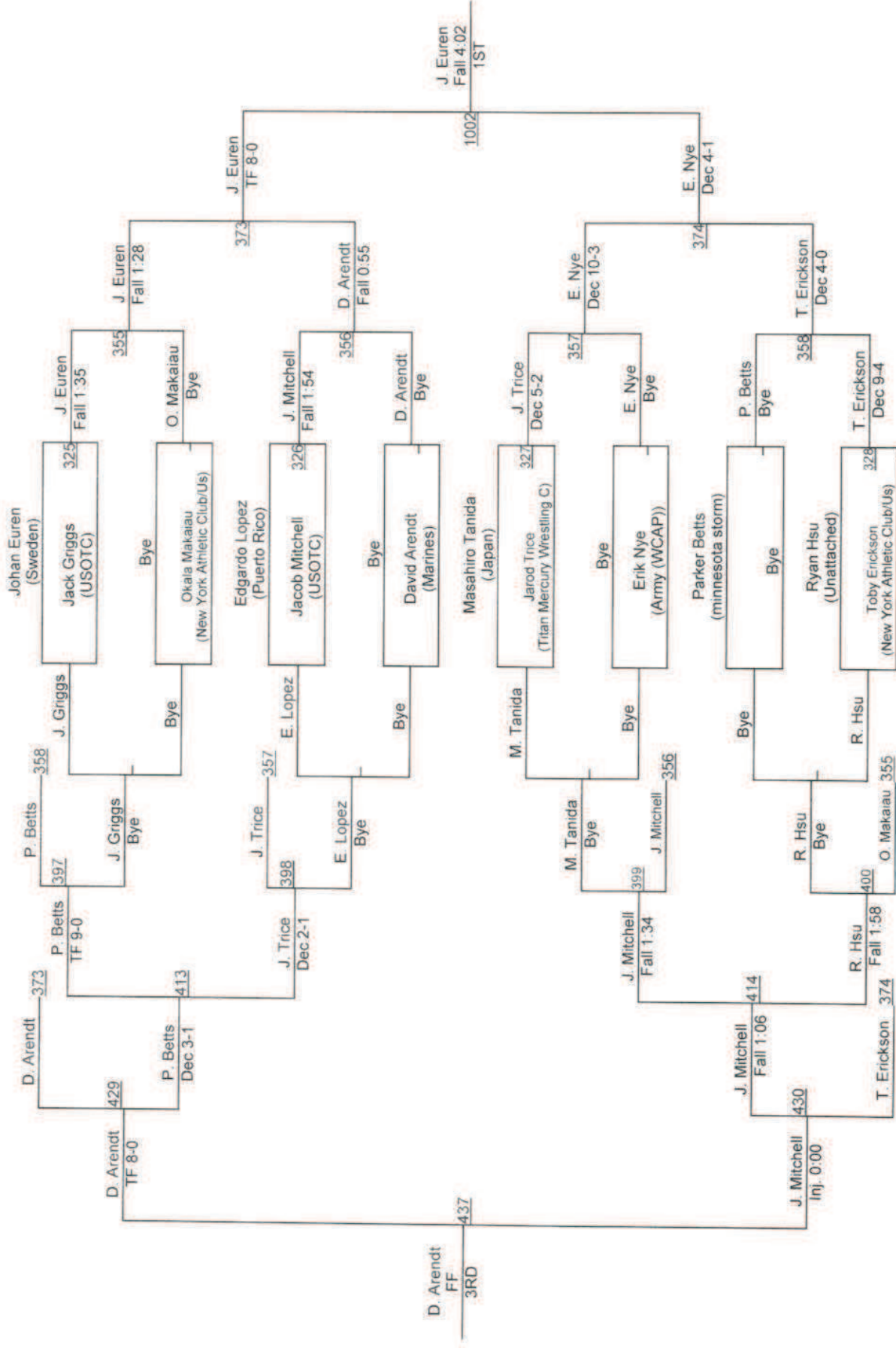

## **2014 Bill Farrell Memorial International**

### **Greco-Roman Results**

#### **GR - 59 KG**

- 1st Place - Mostafa Hassan of Egypt
- 2nd Place - Jermaine Hodge of United States
- 3rd Place - Andrey Tsaryuk of Israel
- 4th Place - Sammy Jones of United States

#### **GR - 66 KG**

- 1st Place - Alejandro Sancho of United States
- 2nd Place - Manuel Alejandro Lopez Salcedo of Mexico
- 3rd Place - Brian Graham of United States
- 4th Place - Victor Adolfo Hidalgo of Mexico

#### **GR - 71 KG**

- 1st Place - Kendrick Sanders of United States
- 2nd Place - Bo Beckman of United States
- 3rd Place - Tomohiro Inoue of Japan
- 4th Place - Dillon Cowan of United States

#### **GR - 75 KG**

- 1st Place - Robert Rosengren of Sweden
- 2nd Place - Juan Angel Escobar of Mexico
- 3rd Place - Geordan Speiller of United States
- 4th Place - Takeshi Izumi of Japan

#### **GR - 80 KG**

- 1st Place - Ben Provisor of United States
- 2nd Place - Patrick Martinez of United States
- 3rd Place - Cheney Haight of United States
- 4th Place - Takayuki Murakami of Japan
- 5th Place - Josh Greer of United States

#### **GR - 85 KG**

- 1st Place - Jon Anderson of United States
- 2nd Place - Zachary Nielsen of United States
- 3rd Place - Masato Sumi of Japan
- 4th Place - Ethan Dondlinger of United States

#### **GR - 98 KG**

- 1st Place - Robert Avanesyan of Israel
- 2nd Place - Fredrik Schoen of Sweden
- 3rd Place - Jose Jair Rocha Barron of Mexico
- 4th Place - Orry Elor of United States

#### **GR - 130 KG**

- 1st Place - Johan Euren of Sweden
- 2nd Place - Erik Nye of United States
- 3rd Place - David Arendt of United States
- 4th Place - Jacob Mitchell of United States

# 2014 Bill Farrell International Open

# WM FS 48 KG

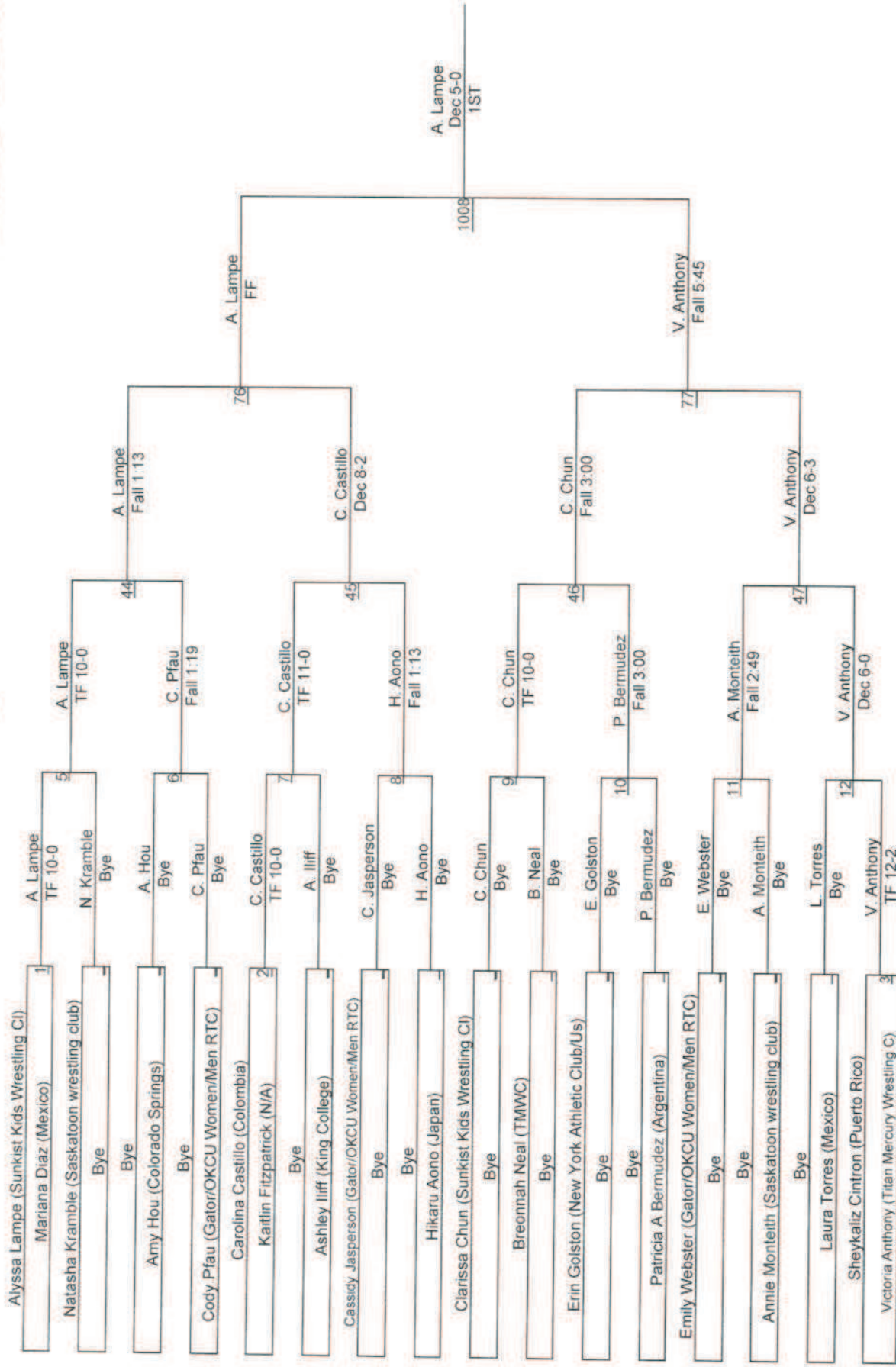



# 2014 Bill Farrell International Open

WM FS 53 KG

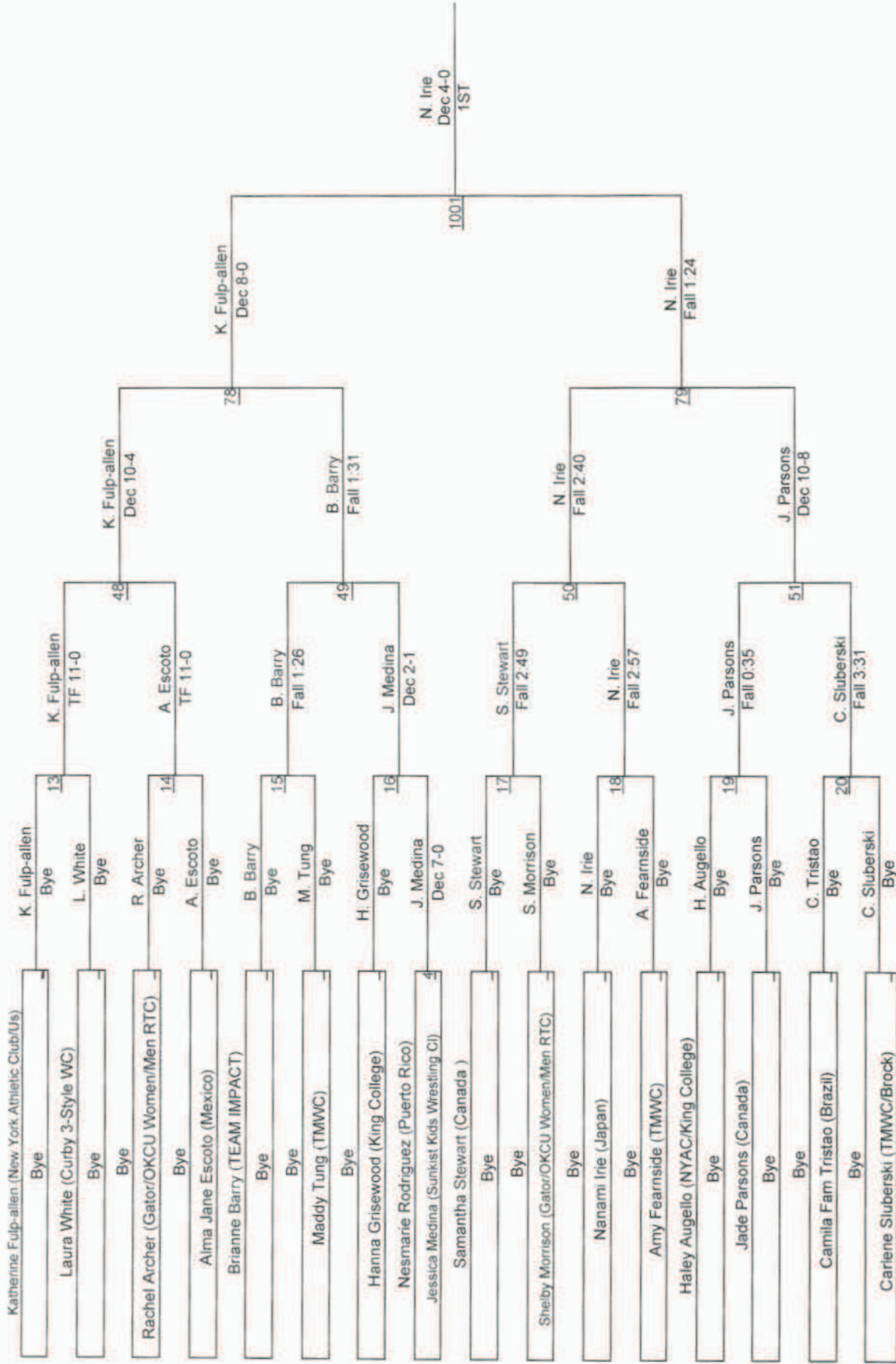

# WM FS 53 KG

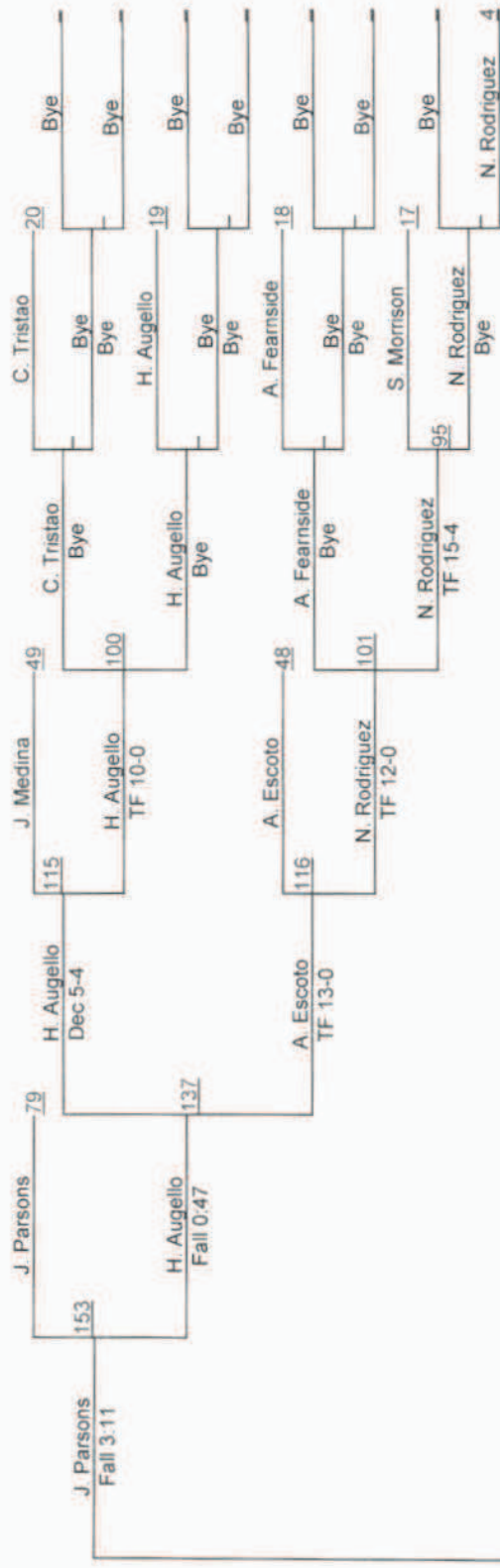

B. Barry  
Dec 7-6  
3RD

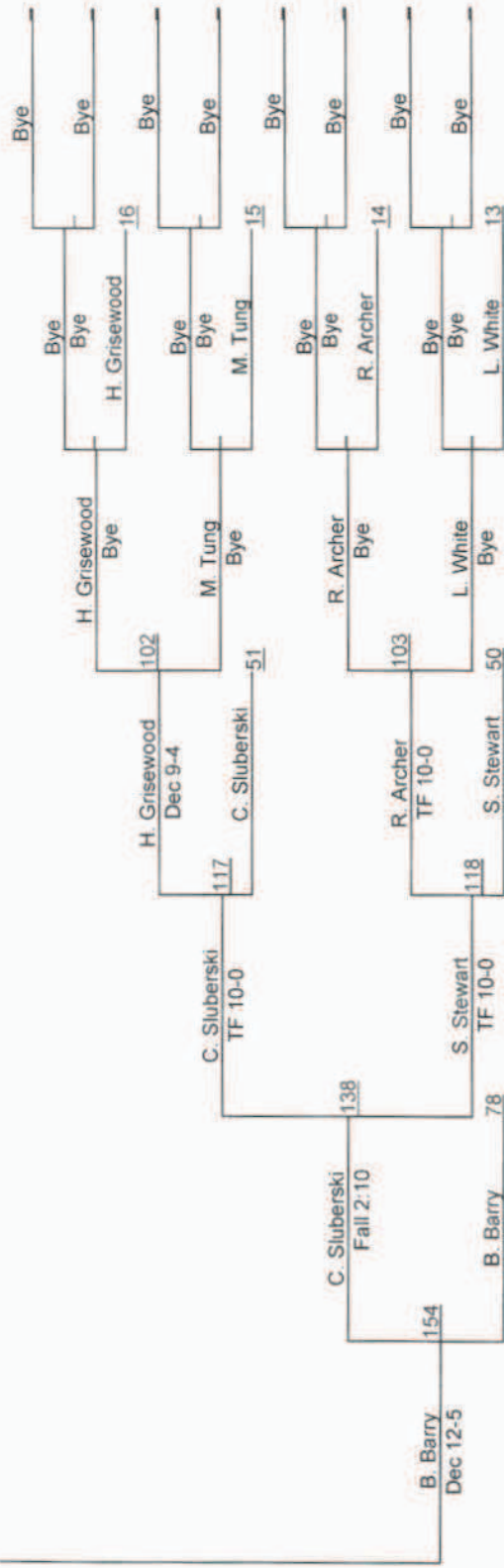



# 2014 Bill Farrell International Open

## WM FS 58 KG

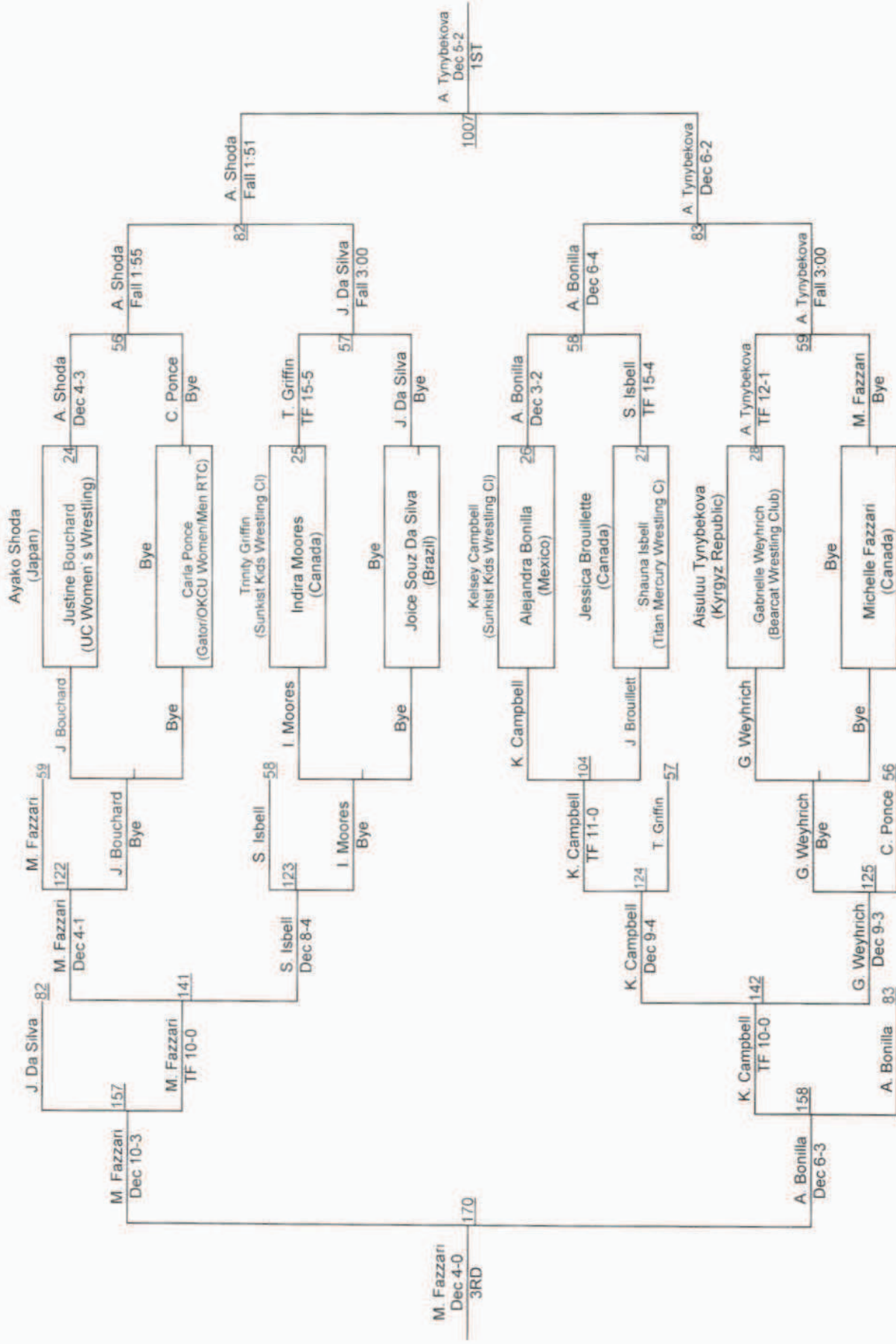









## 2014 Bill Farrell Memorial International

### Female Results

#### WM FS - 48 KG

- 1st Place - Alyssa Lampe of United States
- 2nd Place - Victoria Anthony of United States
- 3rd Place - Patricia Alejandra Bermudez of Argentina
- 4th Place - Clarissa Chun of United States

#### WM FS - 53 KG

- 1st Place - Nanami Irie of Japan
- 2nd Place - Katherine Fulp-allen of United States
- 3rd Place - Brianne Barry of Canada
- 4th Place - Jade Parsons of Canada

#### WM FS - 55 KG

- 1st Place - Kayla Miracle of United States
- 2nd Place - Jacarra Winchester of United States
- 3rd Place - Sarah Hildebrandt of United States
- 4th Place - Jillian Gallays of Canada

#### WM FS - 58 KG

- 1st Place - Aisuluu Tynybekova of Kyrgyz Republic
- 2nd Place - Ayako Shoda of Japan
- 3rd Place - Michelle Fazzari of Canada
- 4th Place - Alejandra Bonilla of Mexico

#### WM FS - 60 KG

- 1st Place - Yoshimi Kayama of Japan
- 2nd Place - Lauren Louive of United States
- 3rd Place - Jenna Burkert of United States
- 4th Place - Kathleen Kent of Canada

#### WM FS - 63 KG

- 1st Place - Jackeline Renteria of Colombia
- 2nd Place - Erin Clodgo of United States
- 3rd Place - Braxton Stone-Papadopoulos of Canada
- 4th Place - Amanda Hendey of United States

#### WM FS - 69 KG

- 1st Place - Randi Miller of United States
- 2nd Place - Veronica Carlson of United States
- 3rd Place - Tamyra Mensah of United States
- 4th Place - Kayoko Kudo of Japan

#### WM FS - 75 KG

- 1st Place - Jackie Cataline of United States
- 2nd Place - Brittney Roberts of United States
- 3rd Place - Andrea Olaya of Colombia
- 4th Place - Aline Da Silva Ferreira of Brazil



# 2014 Bill Farrell International Open

## MFS 61 KG

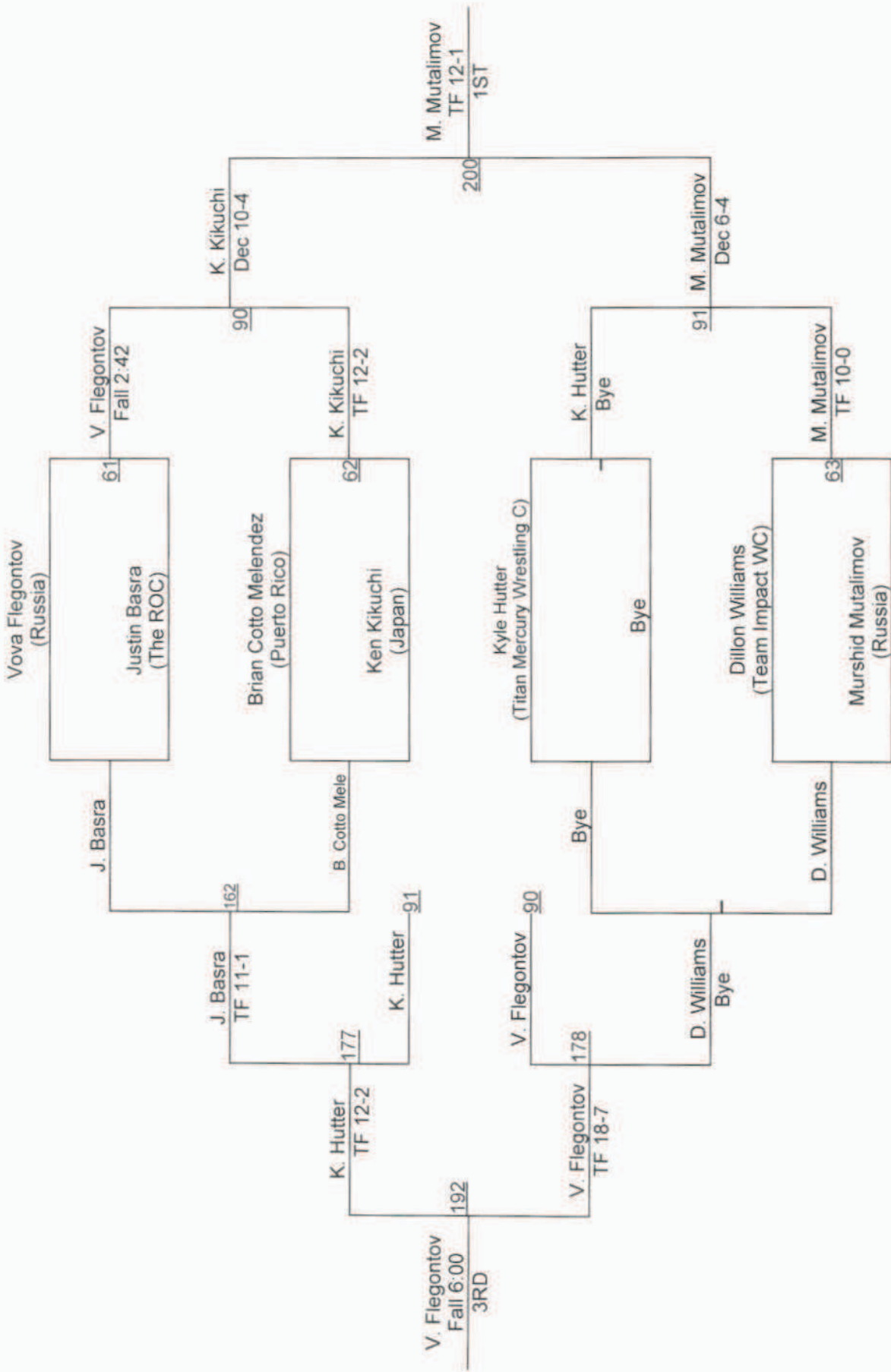

# 2014 Bill Farrell International Open

## MFS 65 KG

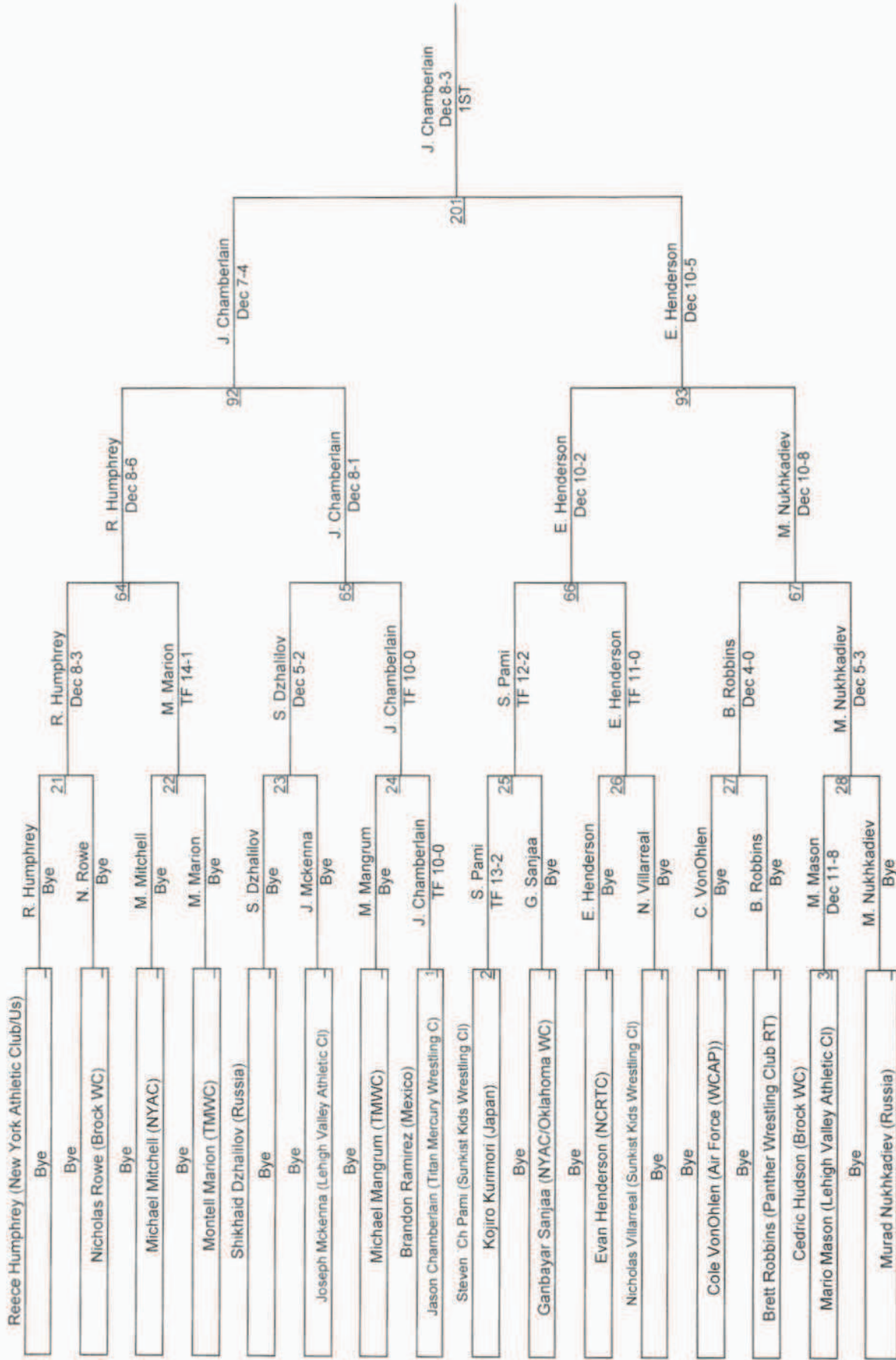

# MFS 65 KG

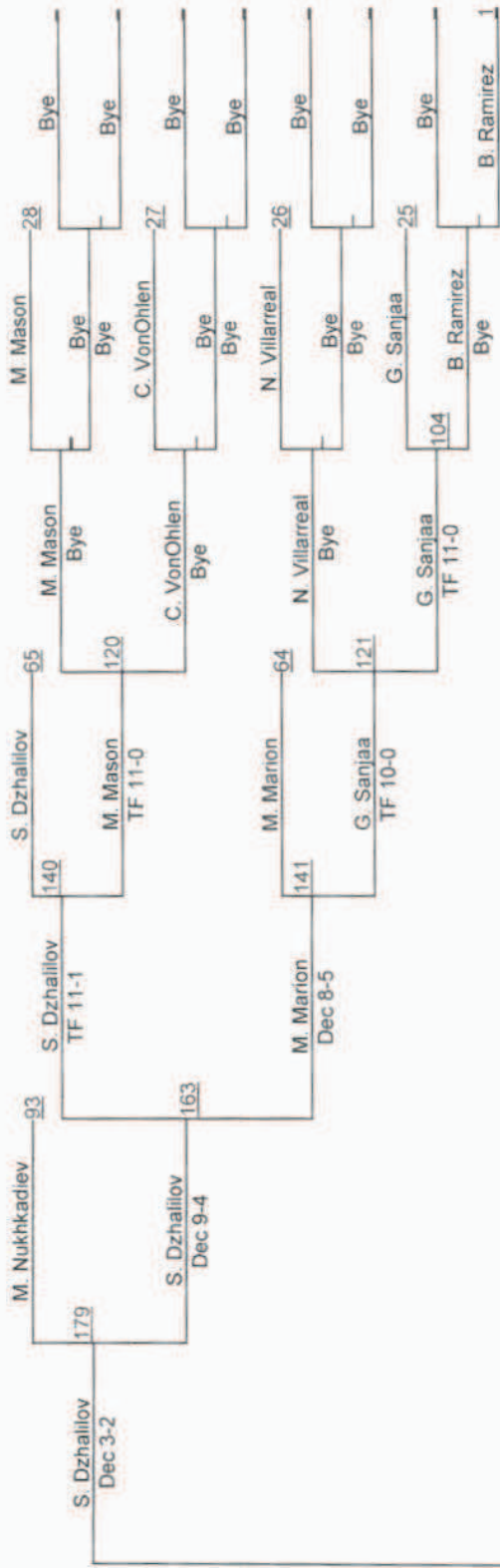

S Dzhalilov  
Dec 5-2  
3RD

193

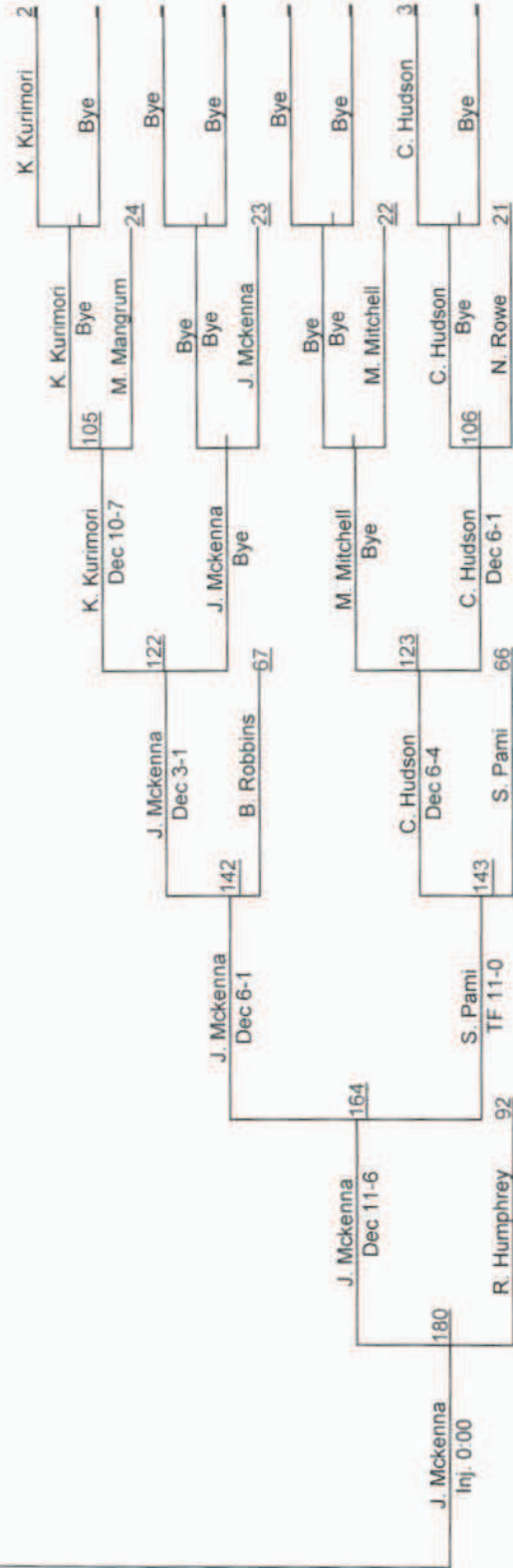

K Kurimori  
2

# 2014 Bill Farrell International Open

# MFS 70 KG

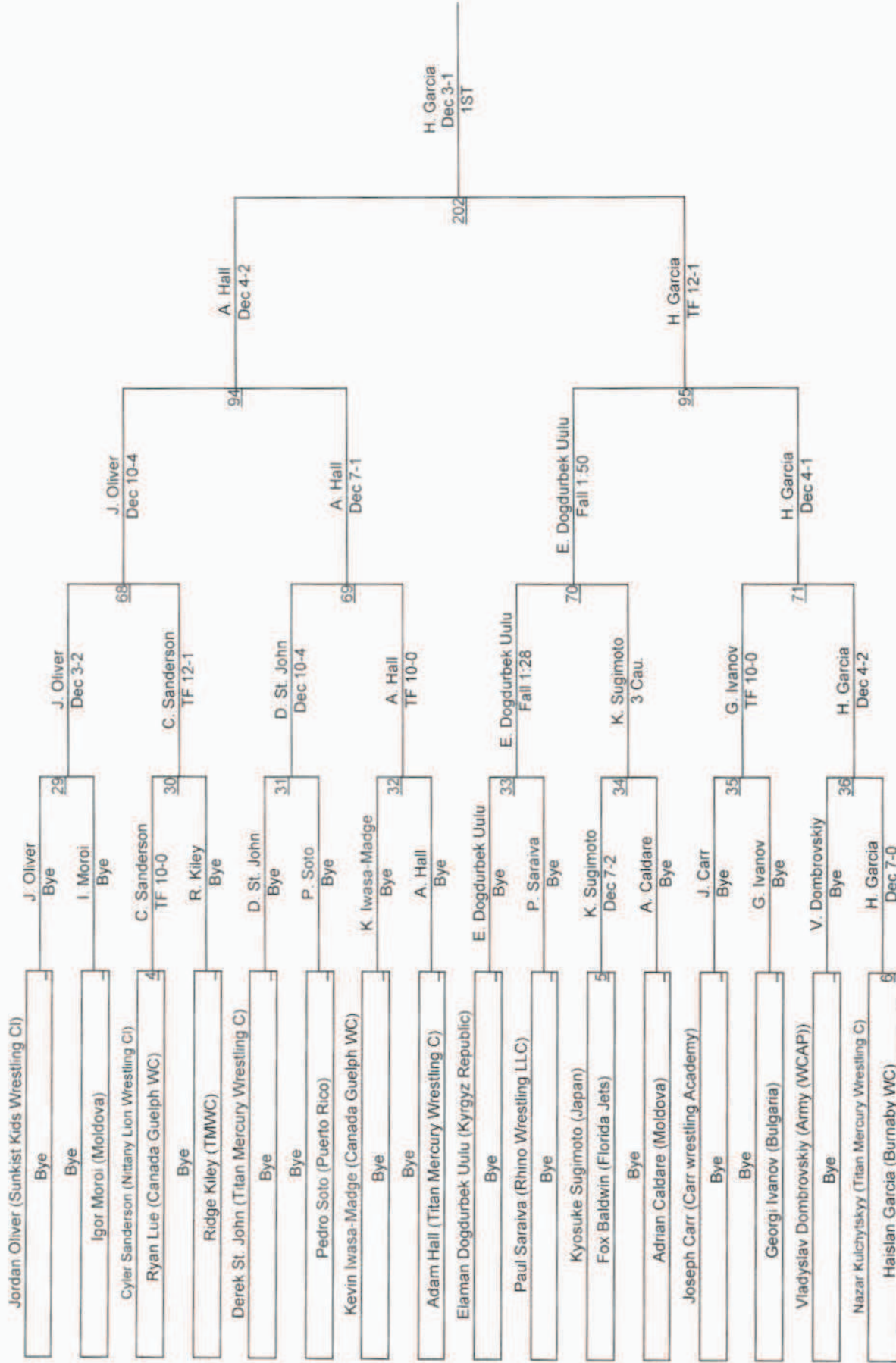



# 2014 Bill Farrell International Open

## MFS 74 KG

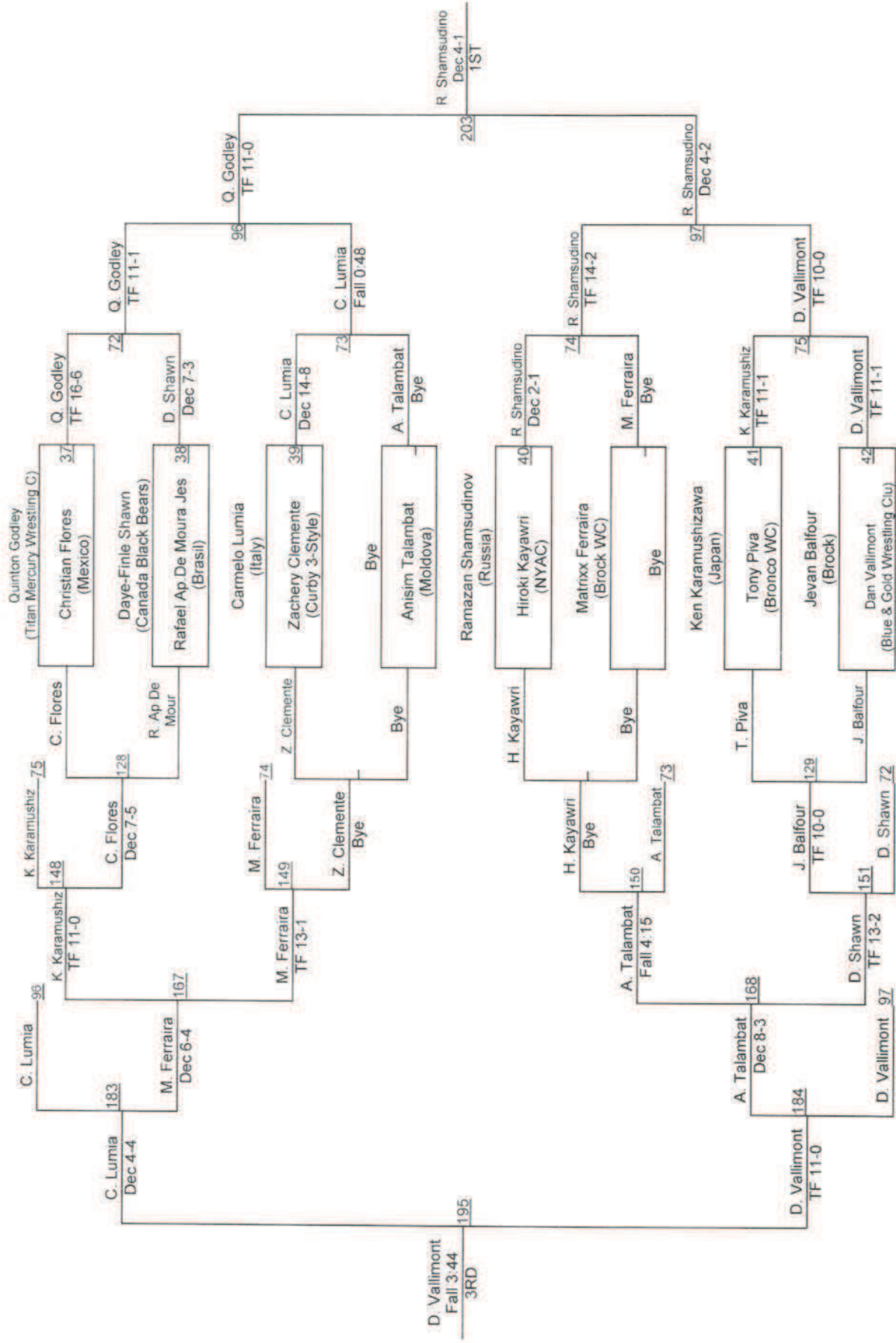

# 2014 Bill Farrell International Open

MFS 86 KG

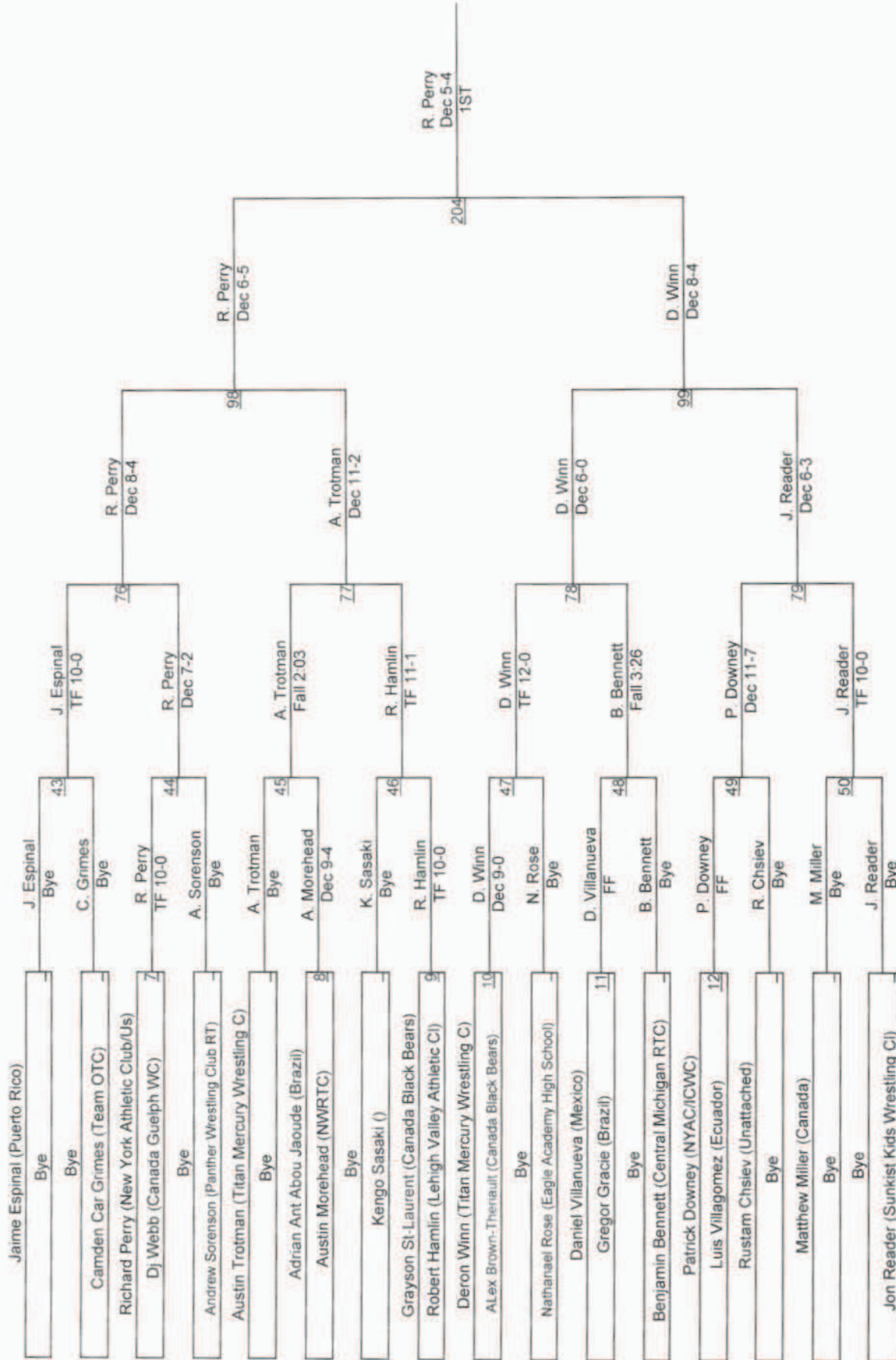

# MFS 86 KG

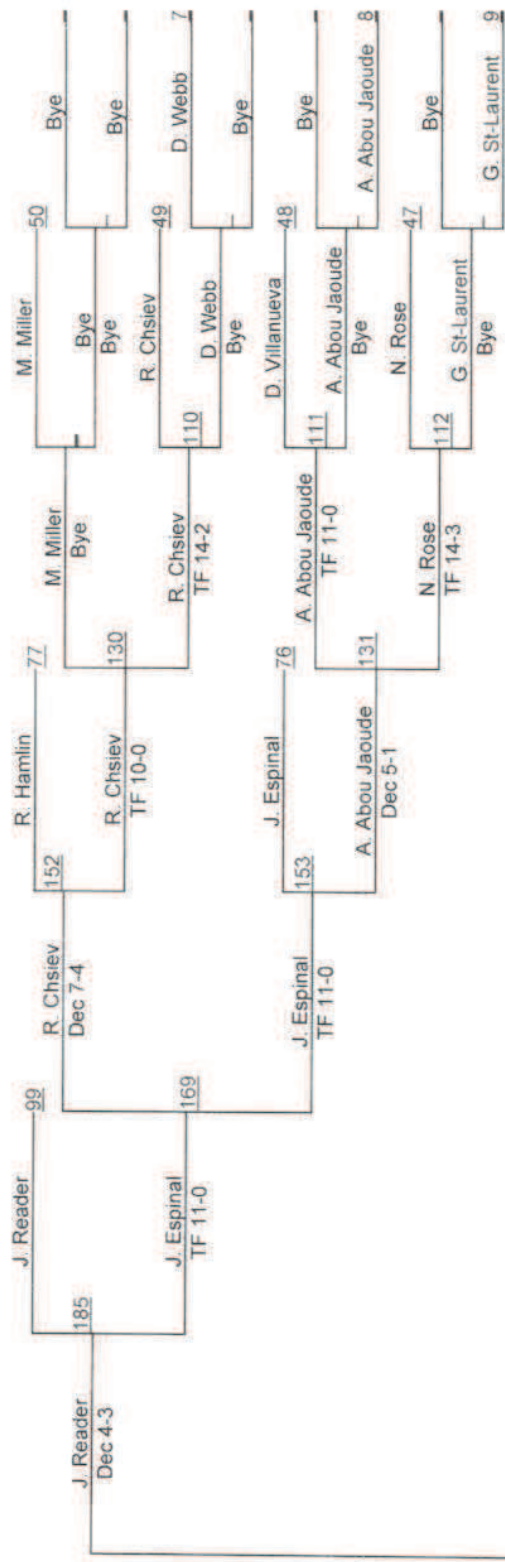

J. Reader  
Dec 10-2  
3RD

196

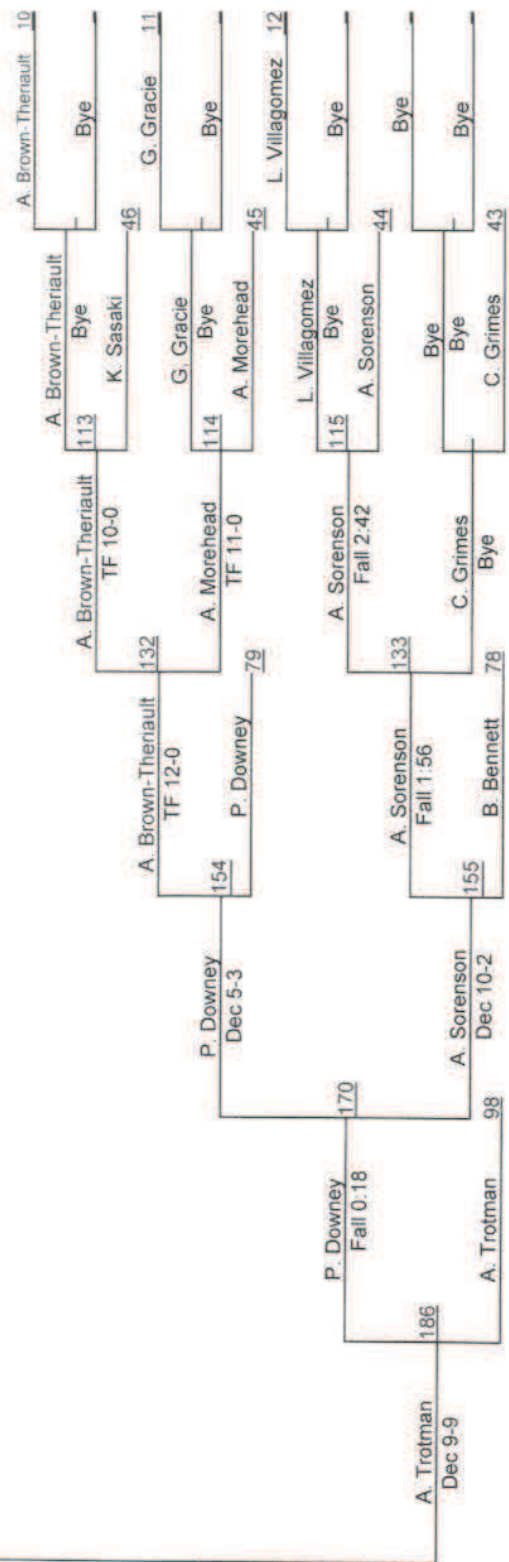





## **2014 Bill Farrell Memorial International**

### **Men's Freestyle Results**

#### **MFS - 57 KG**

- 1st Place - Joe Colon of United States
- 2nd Place - Dan Mitcheff of United States
- 3rd Place - Andrew Hochstrasser of United States
- 4th Place - Rei Kuwaki of Japan

#### **MFS - 61 KG**

- 1st Place - Murshid Mutalimov of Russia
- 2nd Place - Ken Kikuchi of Japan
- 3rd Place - Vova Flegontov of Russia
- 4th Place - Kyle Hutter of United States

#### **MFS - 65 KG**

- 1st Place - Jason Chamberlain of United States
- 2nd Place - Evan Henderson of United States
- 3rd Place - Shikhaid Dzhililov of Russia
- 4th Place - Joseph Mckenna of United States

#### **MFS - 70 KG**

- 1st Place - Haislan Garcia of Canada
- 2nd Place - Adam Hall of United States
- 3rd Place - Jordan Oliver of United States
- 4th Place - Cyler Sanderson of United States

#### **MFS - 74 KG**

- 1st Place - Ramazan Shamsudinov of Russia
- 2nd Place - Quinton Godley of United States
- 3rd Place - Dan Vallimont of United States
- 4th Place - Carmelo Lumia of Italy

#### **MFS - 86 KG**

- 1st Place - Richard Perry of United States
- 2nd Place - Deron Winn of United States
- 3rd Place - Jon Reader of United States
- 4th Place - Austin Trotman of United States

#### **MFS - 97 KG**

- 1st Place - Enock Francois of United States
- 2nd Place - Manjot Sandhu of Canada
- 3rd Place - Matt Gibson of United States
- 4th Place - Jesse Prudente Ruiz Flores of Mexico

#### **MFS - 125 KG**

- 1st Place - Tyrell Fortune of United States
- 2nd Place - Dom Bradley of United States
- 3rd Place - Pavel Krivtsov of Russia
- 4th Place - Eric Thompson of United States